

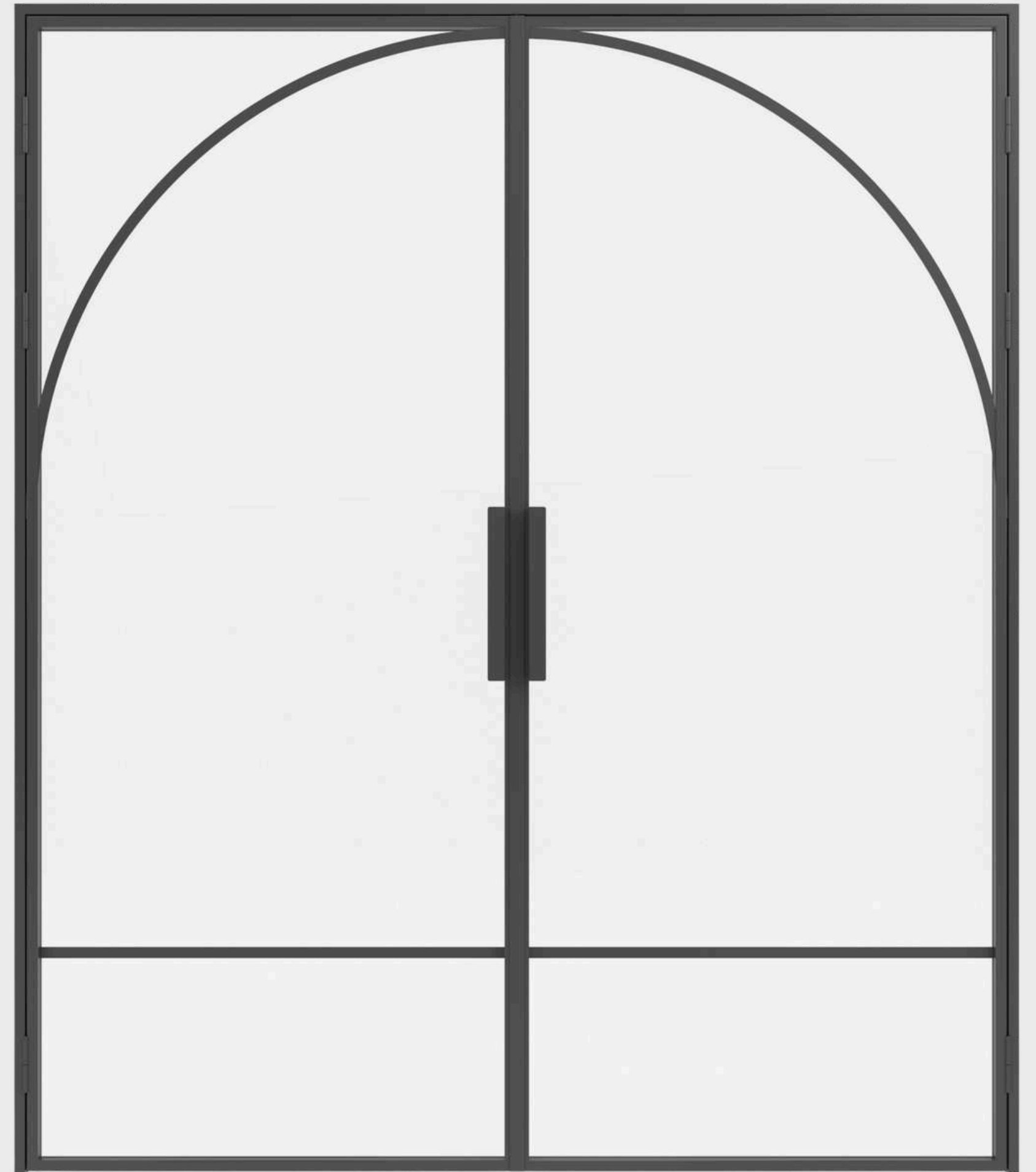

Loft Slim

Custom Steel Doors Catalogue
iconsteeldoor.co.uk



Why Loft Slim?

Loft Slim series of internal steel doors is distinguished by its sharp aesthetic, due to 20x42mm steel frames.

It features:

- Ultra-slim 20 mm visible profiles
- Steel frames made with CNC precision
- Standard and metallic finish palette
- Range of clear and ornament glass (up to 8mm)
- Stick-on and welded bars in custom patterns

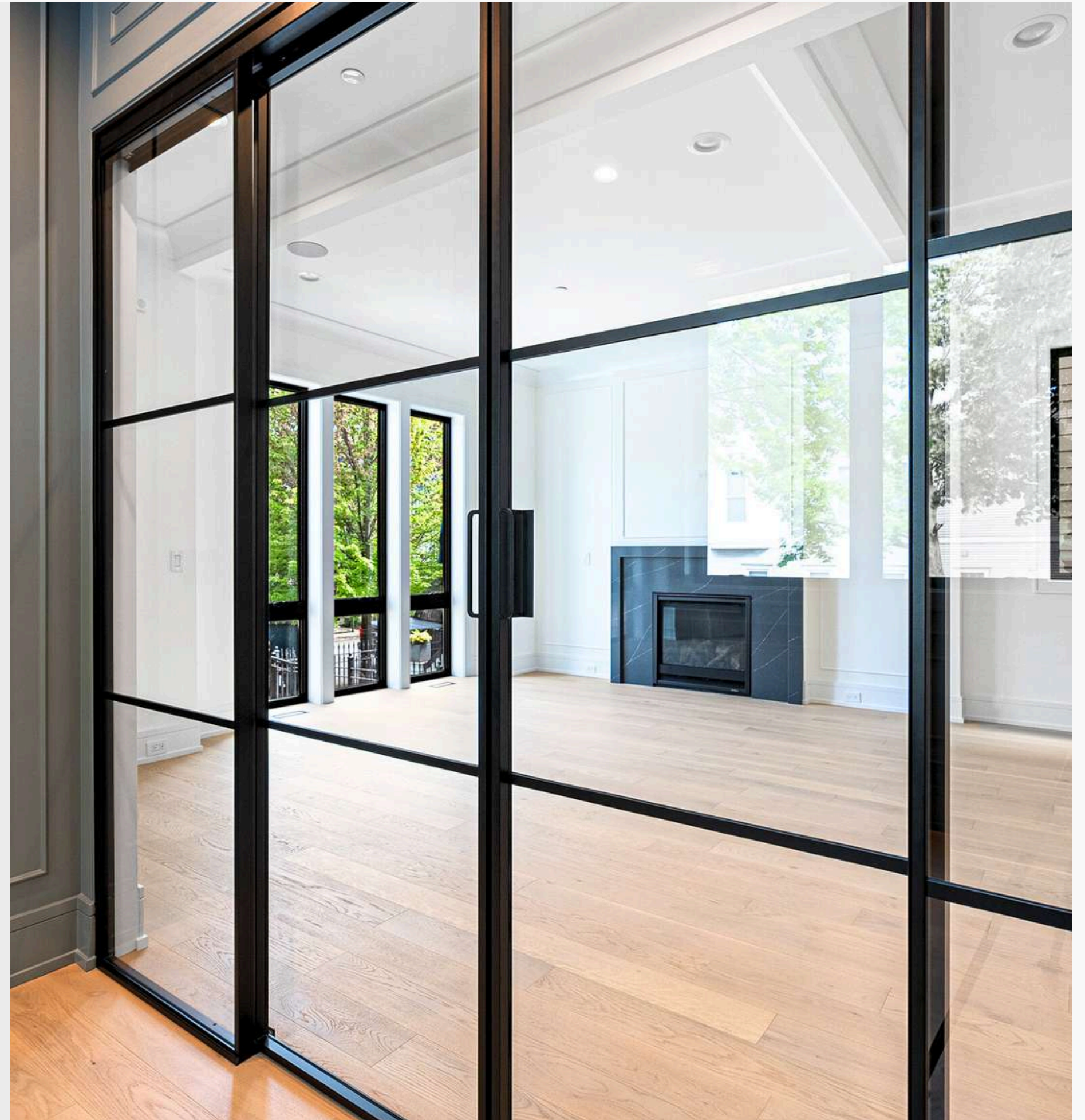

Loft Slim Profile System

Profile System Dimensions

	width	height
door leaf	40 mm	20 mm
door frame	50 mm	20 mm
total set leaf + door frame	50 mm	44 mm

Profile System Characteristic

parameter	characteristic
frame material	steel
finish	powder coating
glazing bead material	aluminum
glazing bead mount	mechanical click-on
glass range	4 - 8 mm
hinges	welded
joints	welded
bars	construction steel or aluminium stick-on

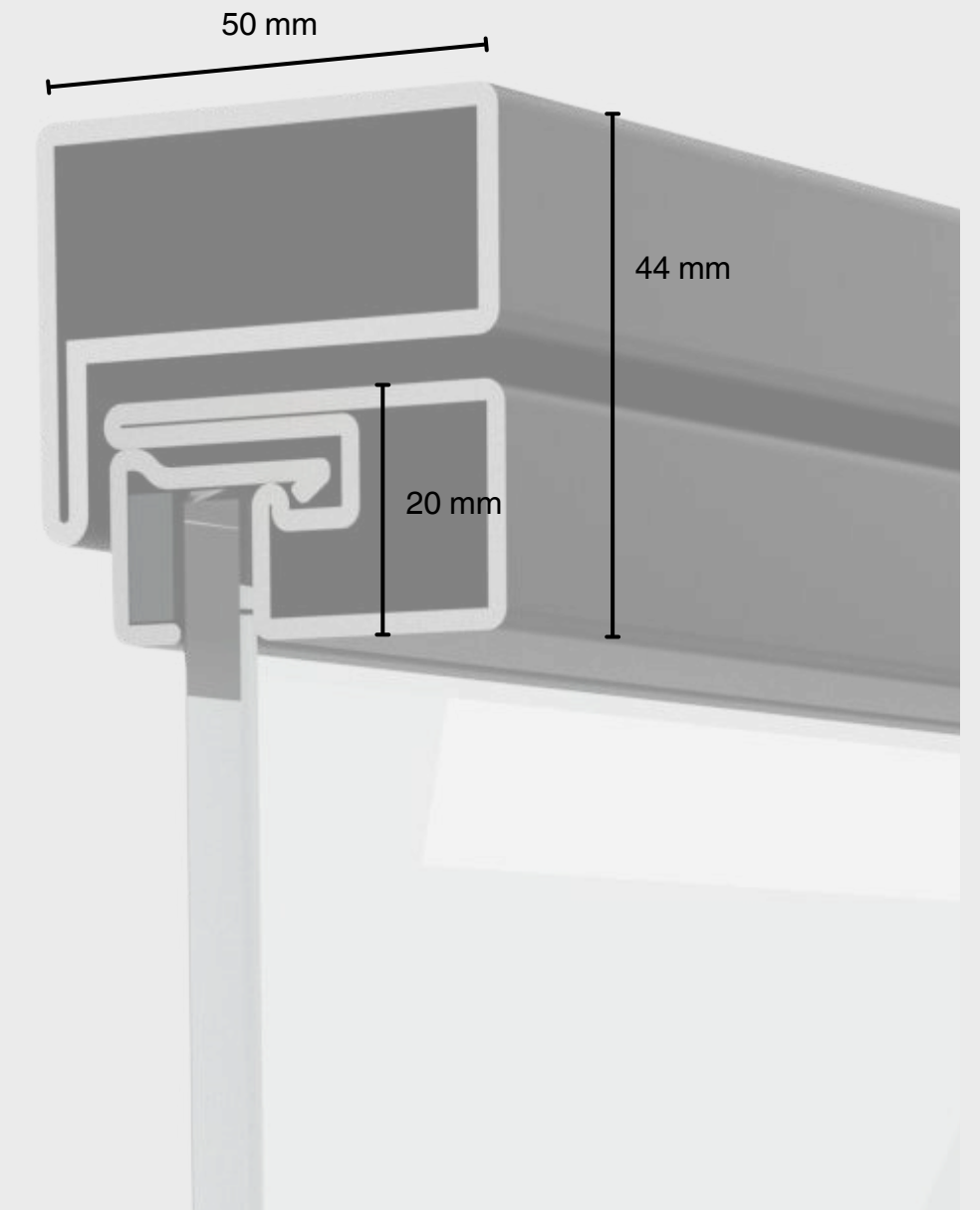

INTERNAL USE



NON FIRE RATED

Premium vs Custom

At Icon Loft we offer Premium Standard & Custom Studio Options.

	Premium	Custom
outside of production limits	o	x
6mm Clear safety glass	x	x
Custom Glass Range	o	x
Single Doors	x	x
Double Doors	x	x
Sliding Doors	o	x
Pivot Doors	o	x
Bi-Folding Doors	o	x
Fixed Panels	x	x
Arched Panels	o	x
Arched Doors	o	x
Arched Bars	o	x
Custom Bar Layouts	o	x
Welded Bars	o	x
Kickpanels	o	x
Standard Lock Casette	o	x
Customized Lock Casette	o	x
Hammered Pull Handles	o	x
Custom Handles Line	o	x
Premium Pull Handles Line	x	x
Custom Pull Handles Line	o	x
Premium RAL palette	x	x
Custom RAL palette	o	x
Tiger palette	o	x

Loft Slim swing doors

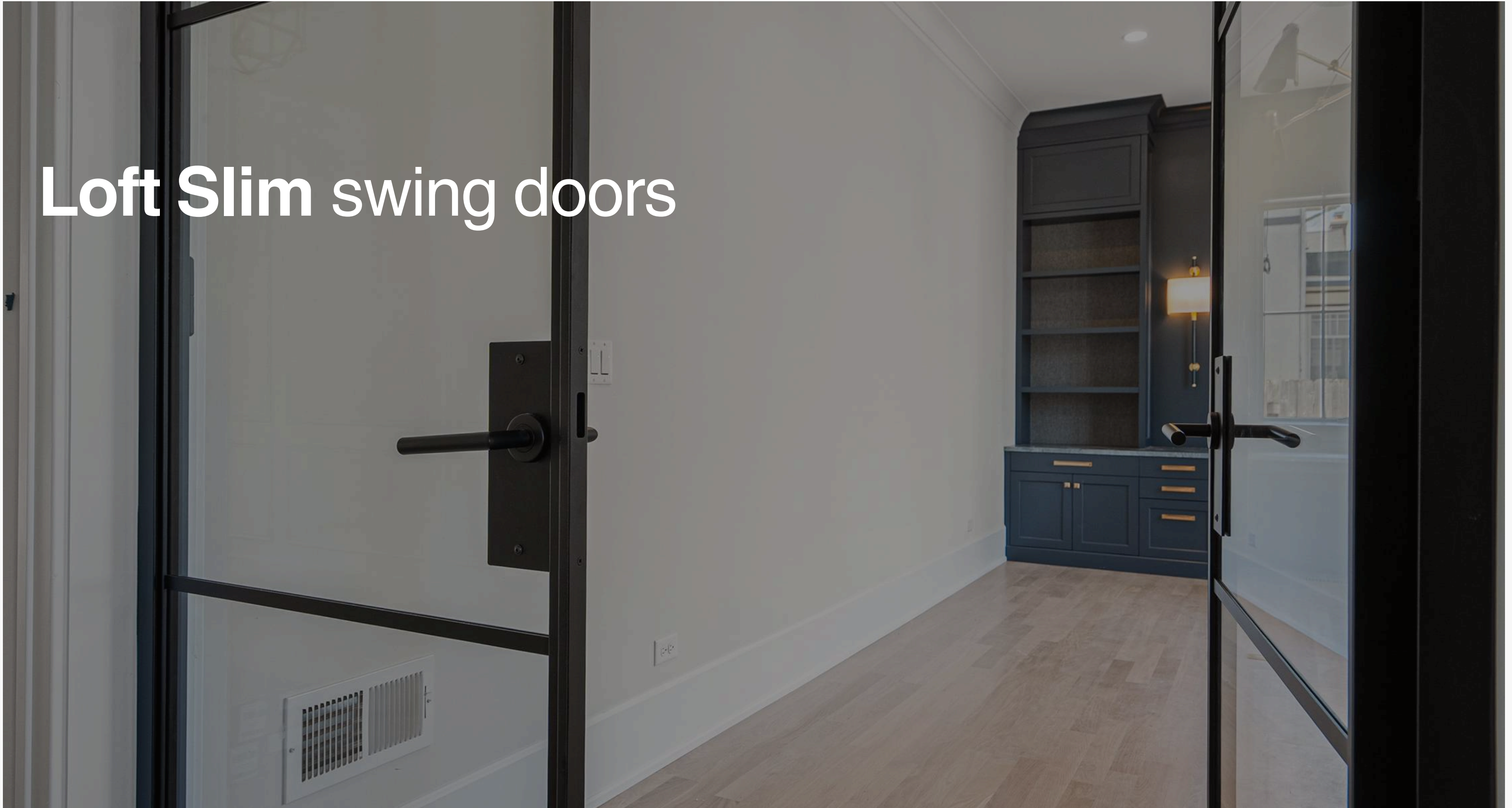

Loft Slim Swing Doors

Loft Slim Swing Collection is an architectural system capable of creating sharp aesthetic single and double doors that can also be combined with fixed panels on sides and on top.

Loft Slim Swing Collection doors are made of minimalistic 20x42mm, high grade cold rolled steel profiles.

Our steel doors are powder coated then fitted with top quality glass range.

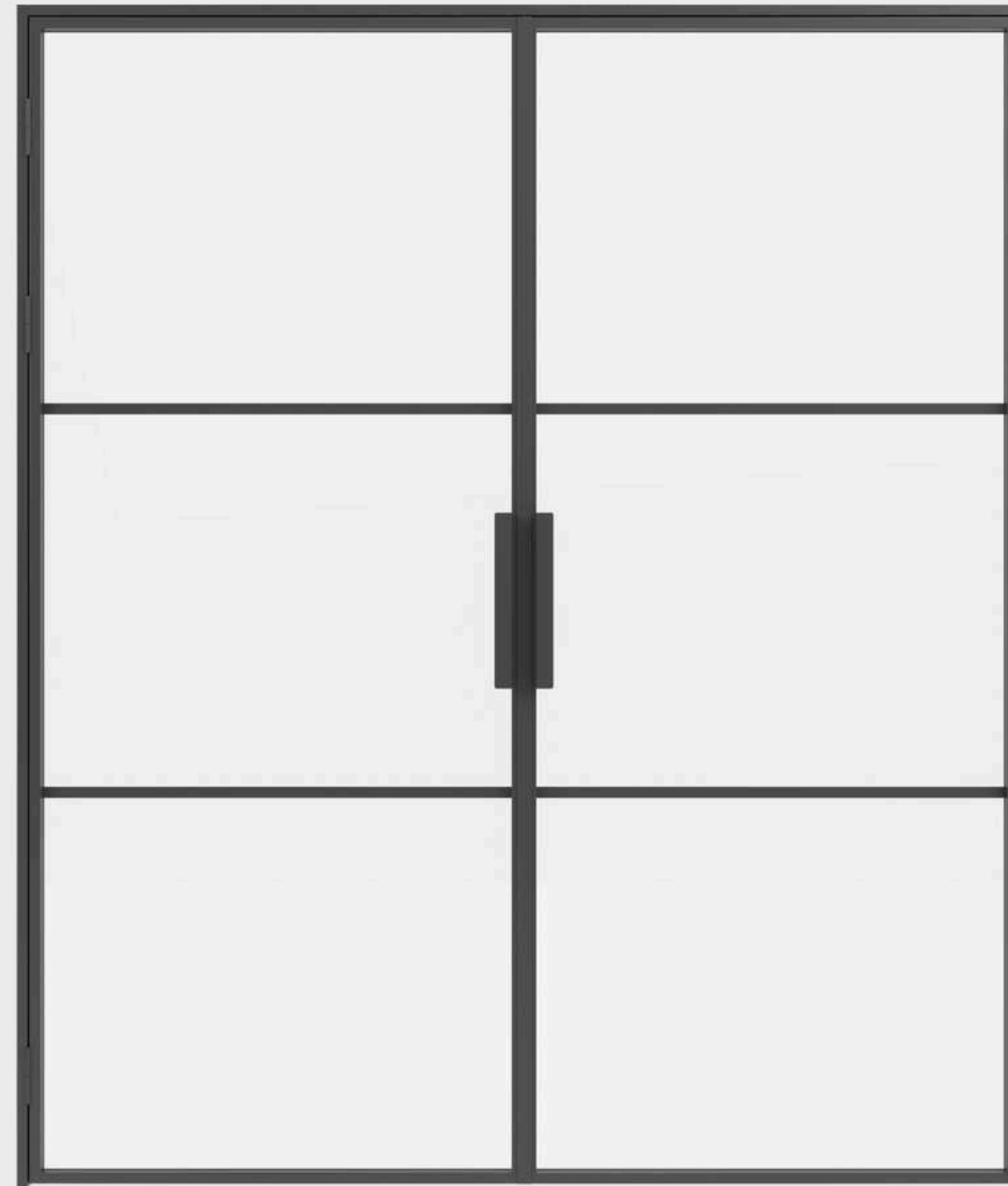

Fabrication limits:

	min	max
door leaf width [mm]	550	1100
door leaf height [mm]	1800	4000

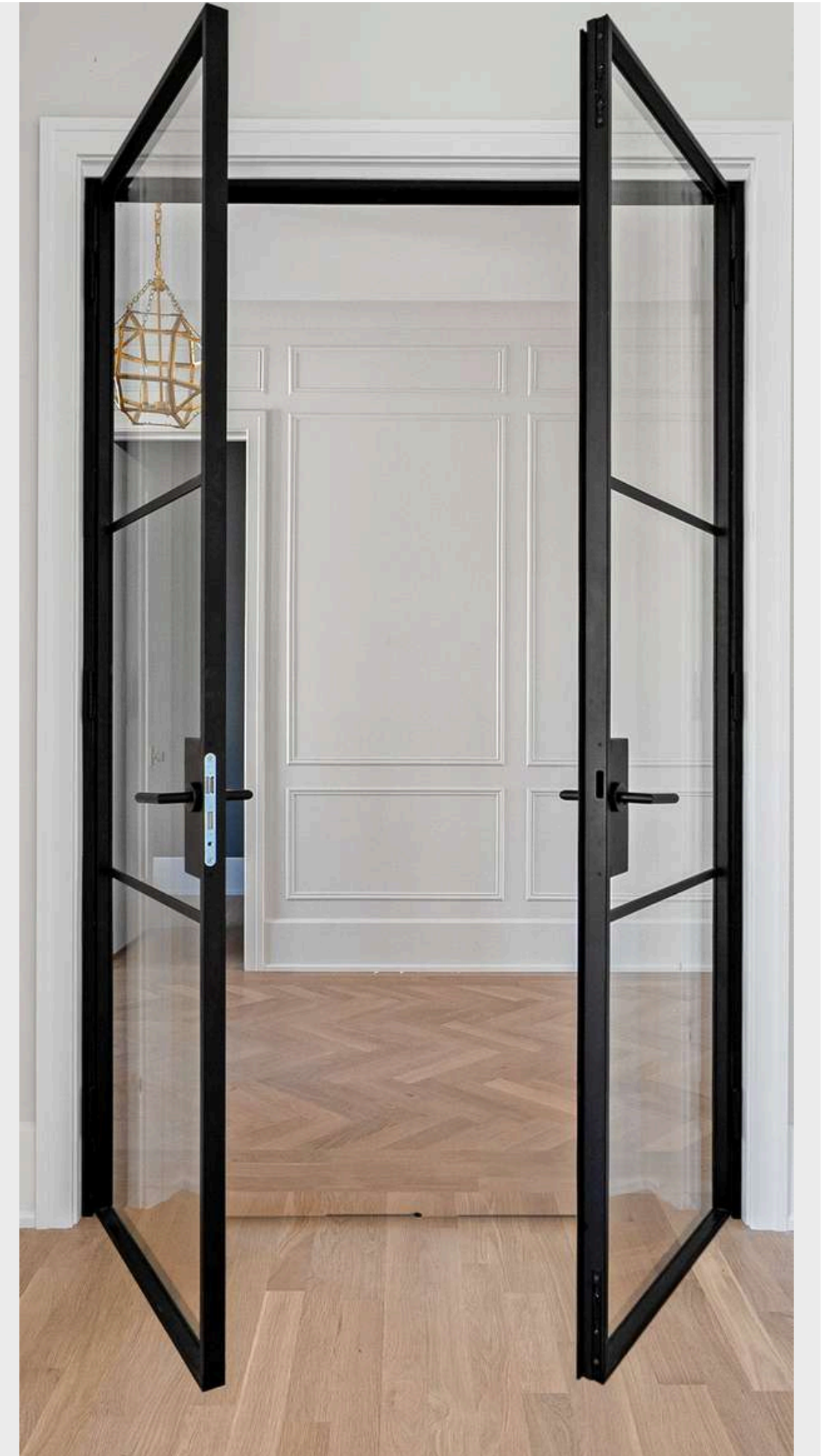
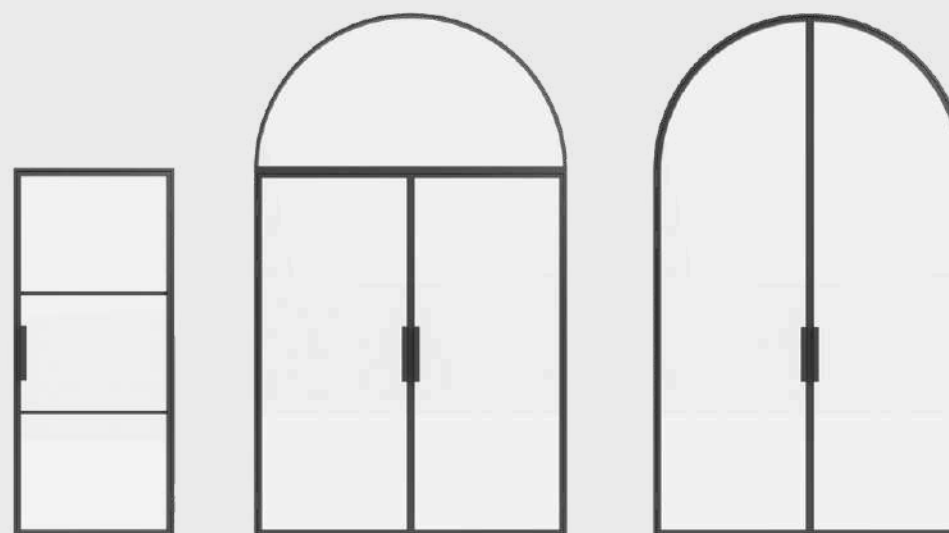

Loft Slim Swing Doors + Fixed Panels

The Icon Loft Slim fixed panel system is defined by its minimalist lines and ultra-slim steel profiles, designed to create clear and elegant divisions within a space.

With no need for moving parts, fixed panels offer a practical way to build partition walls or separate zones while maintaining openness and light flow.

Thanks to the refined geometry and flexibility of the system, panels can be used alone or in combination with hinged, sliding, or pivot doors to form complete steel and glass installations.

Fabrication limits:

	min	max
door leaf width [mm]	550	1500
door leaf height [mm]	1800	4000

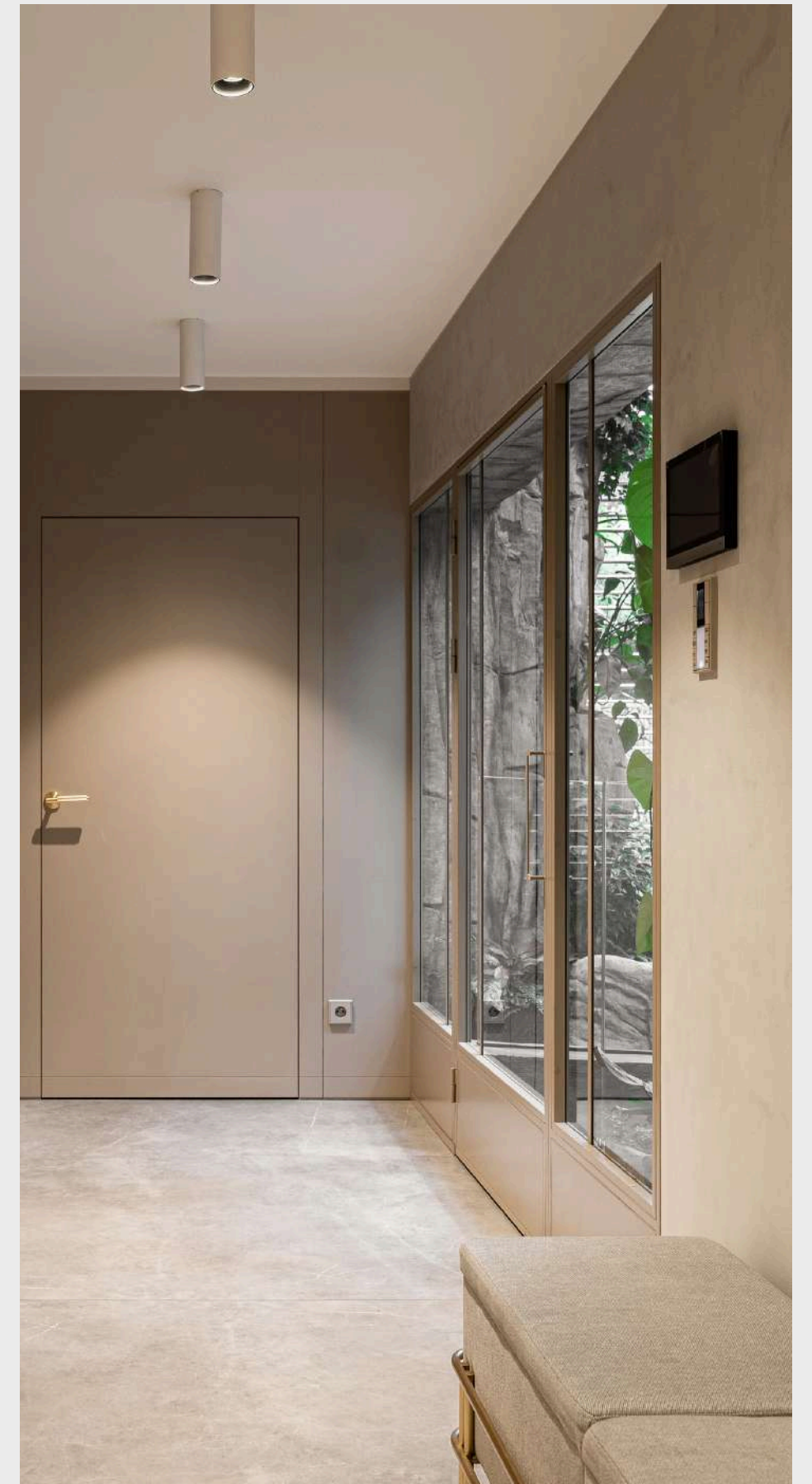
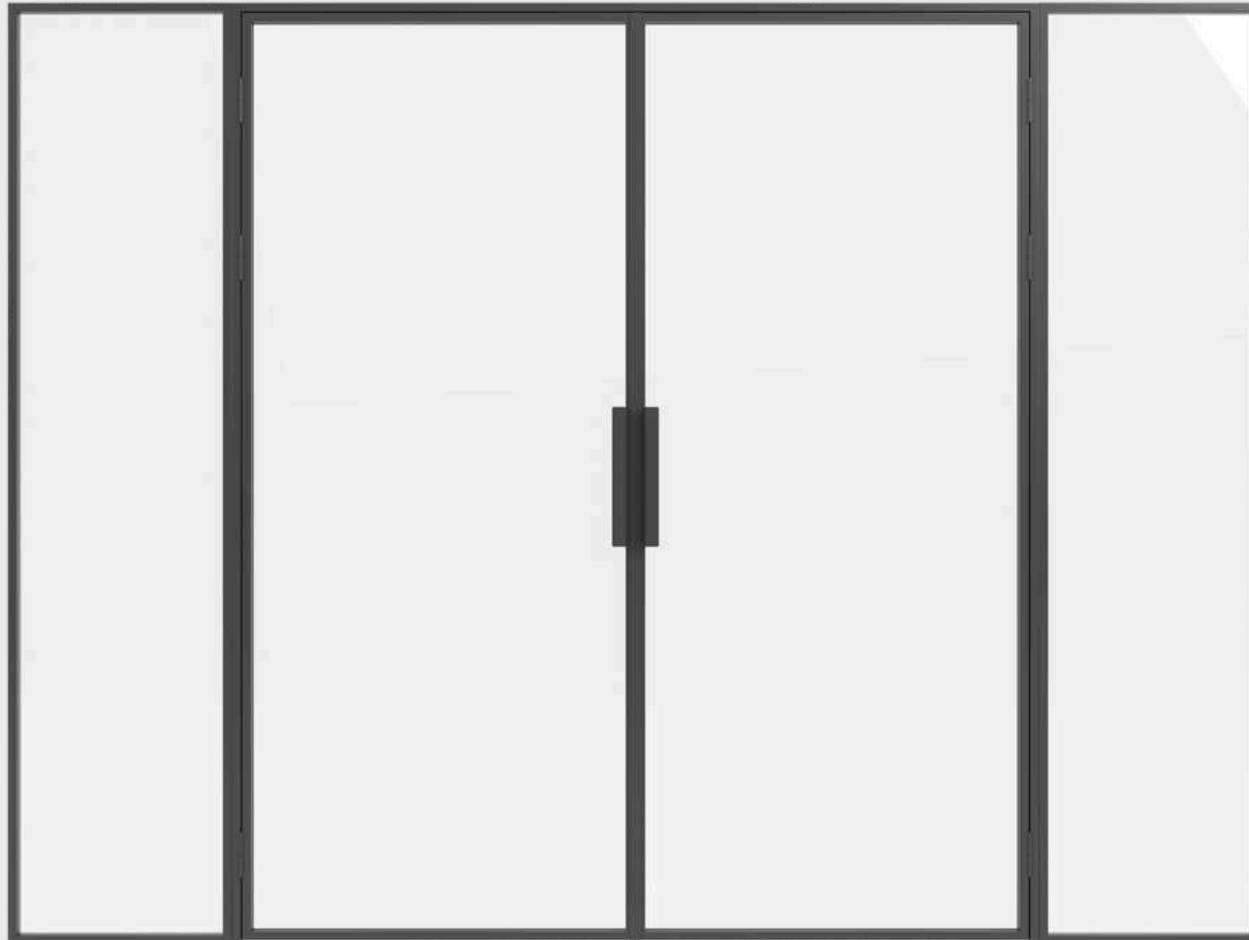

Loft Slim Swing Doors Installation Details

Icon Loft Slim Swing Doors are designed for quick and simple installation. The frame comes with pre-prepared mounting holes, making it easy to fix the door using standard screws and wall plugs.

Once the installation is complete, the holes are concealed with specially made plastic caps from Icon, painted in the same color as the frame.

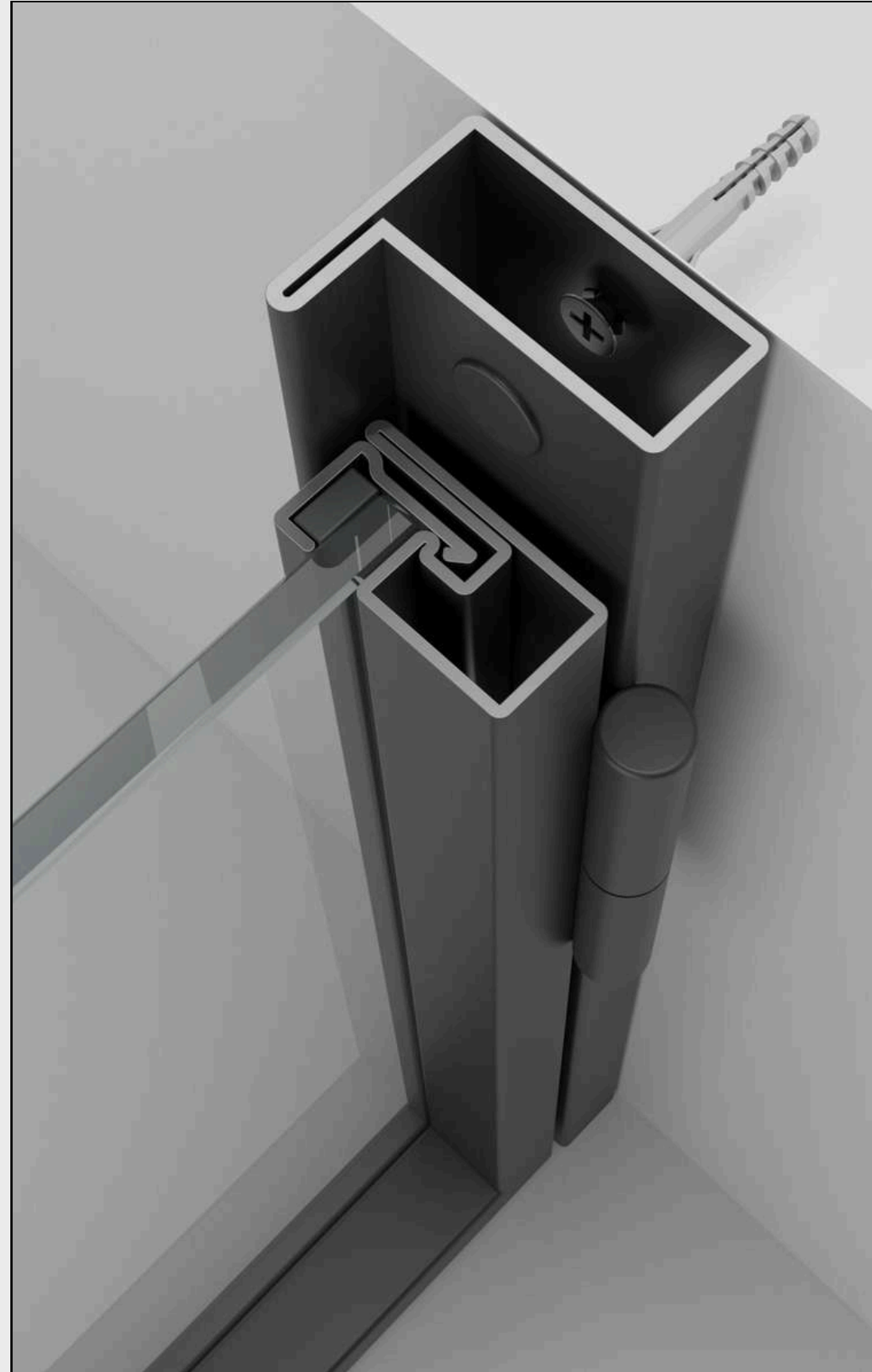

Loft Slim sliding doors



Loft Slim Sliding Doors

Icon Loft Slim Sliding Doors are built with a 20x42 mm slim profile system, designed to create elegant and functional sliding solutions. The system allows for single or multi-track configurations, offering flexibility for different spaces.

Floor guides ensure stability and prevent wobbling, while optional soft-close mechanisms add comfort and safety in everyday use. The doors can be mounted on the wall or ceiling, and additional fixed panels can be placed on the sides or above, allowing for custom layouts tailored to each project.

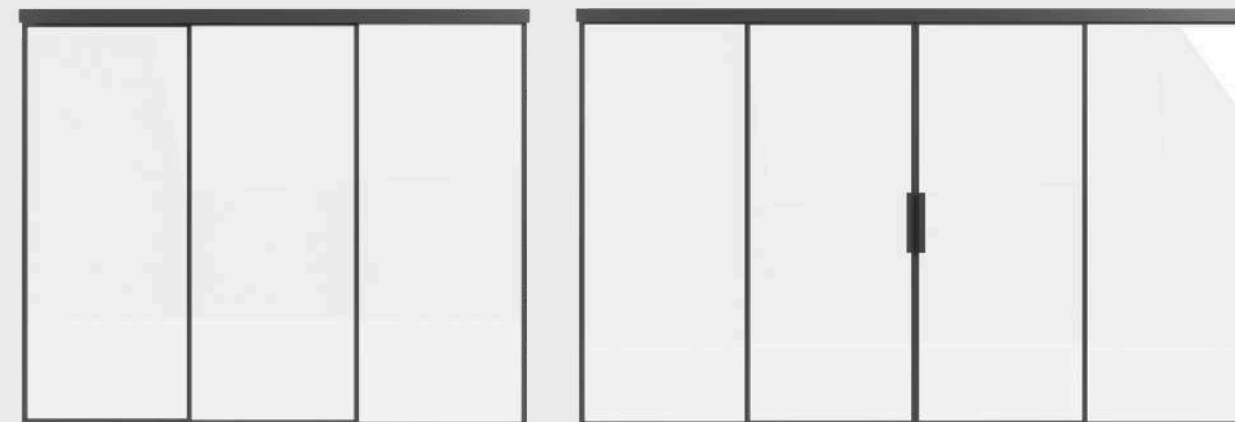
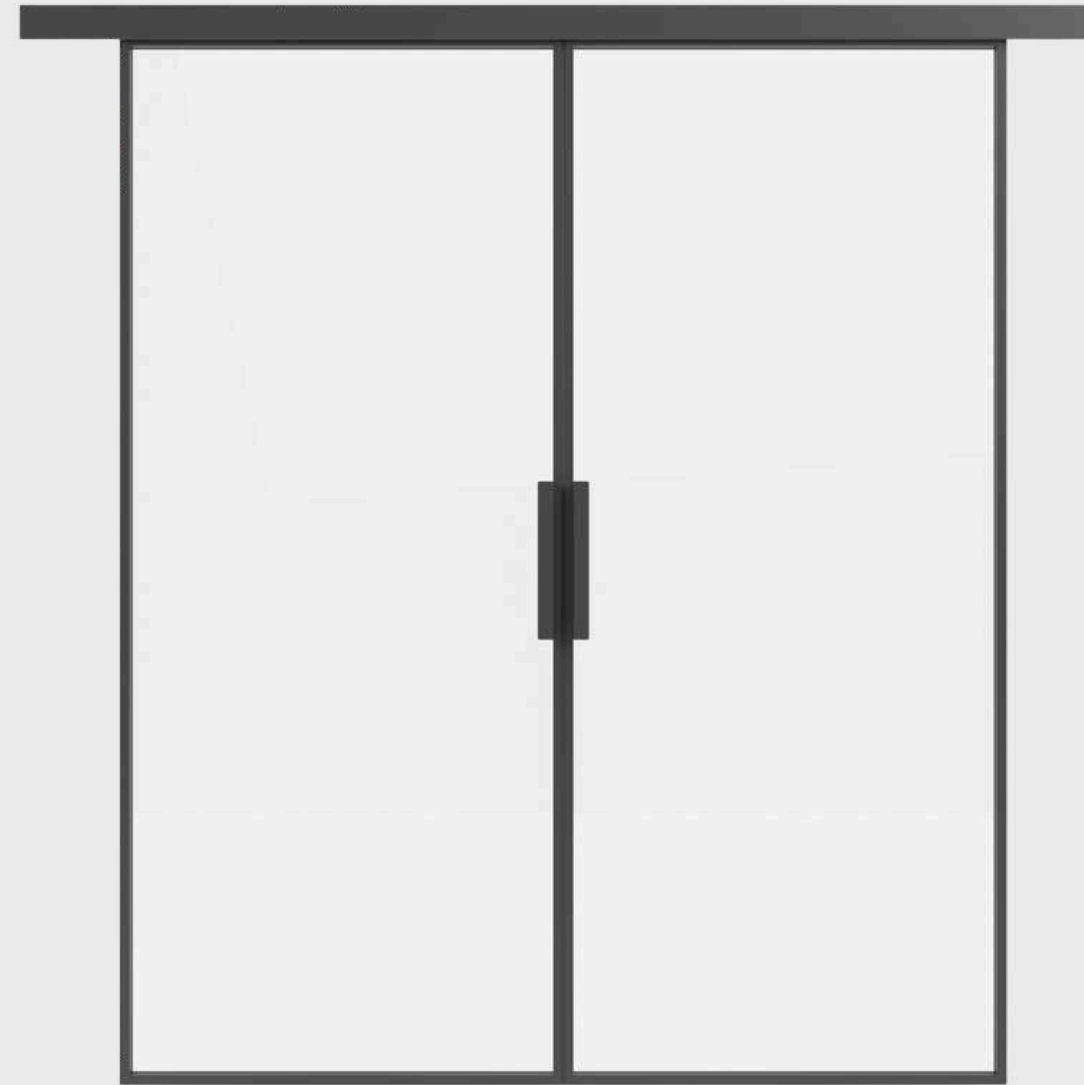

Fabrication limits:

	min	max
door leaf width [mm]	550	1100
door leaf width [mm]	1800	4000



Loft Slim Sliding Doors

The Loft Slim collection offers two rail types: ceiling-mounted and wall face-mounted. Both options support multi-track systems, allowing multiple panels to slide independently for flexible layouts. On the floor, an invisible guide keeps the doors stable—preventing any unwanted movement or swaying.

Wall mounted sliding rail

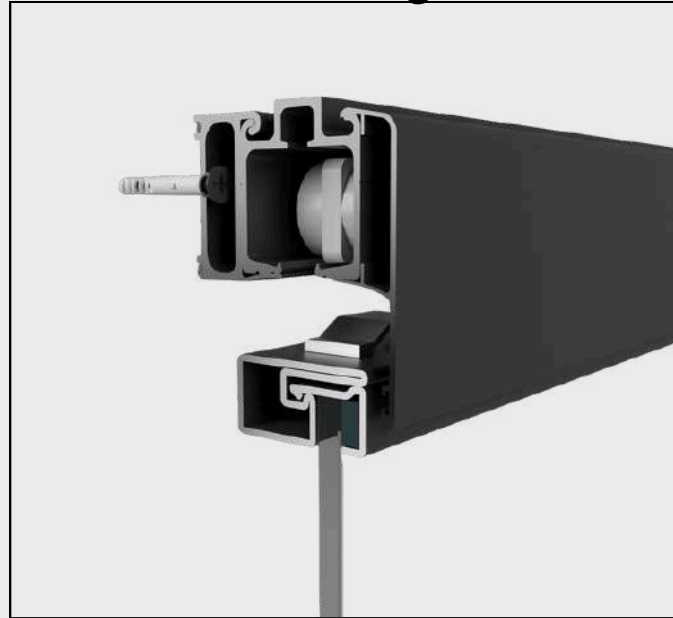

Ceiling mounted sliding rail

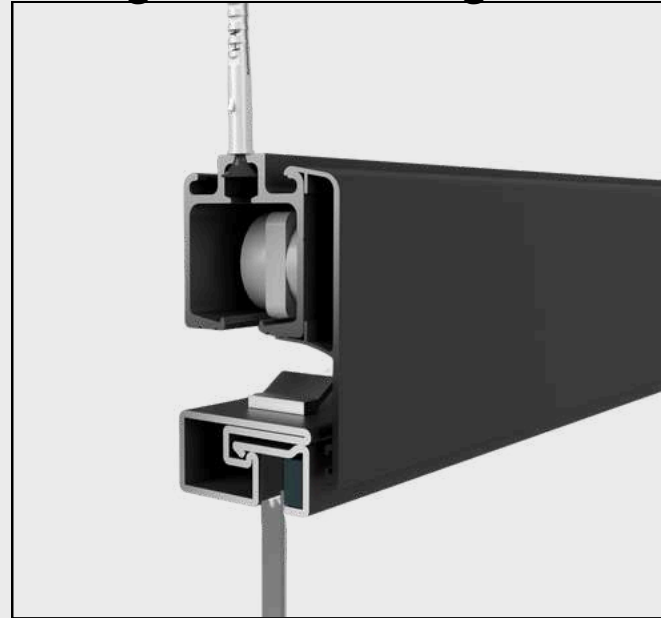

Concealed lower door guide

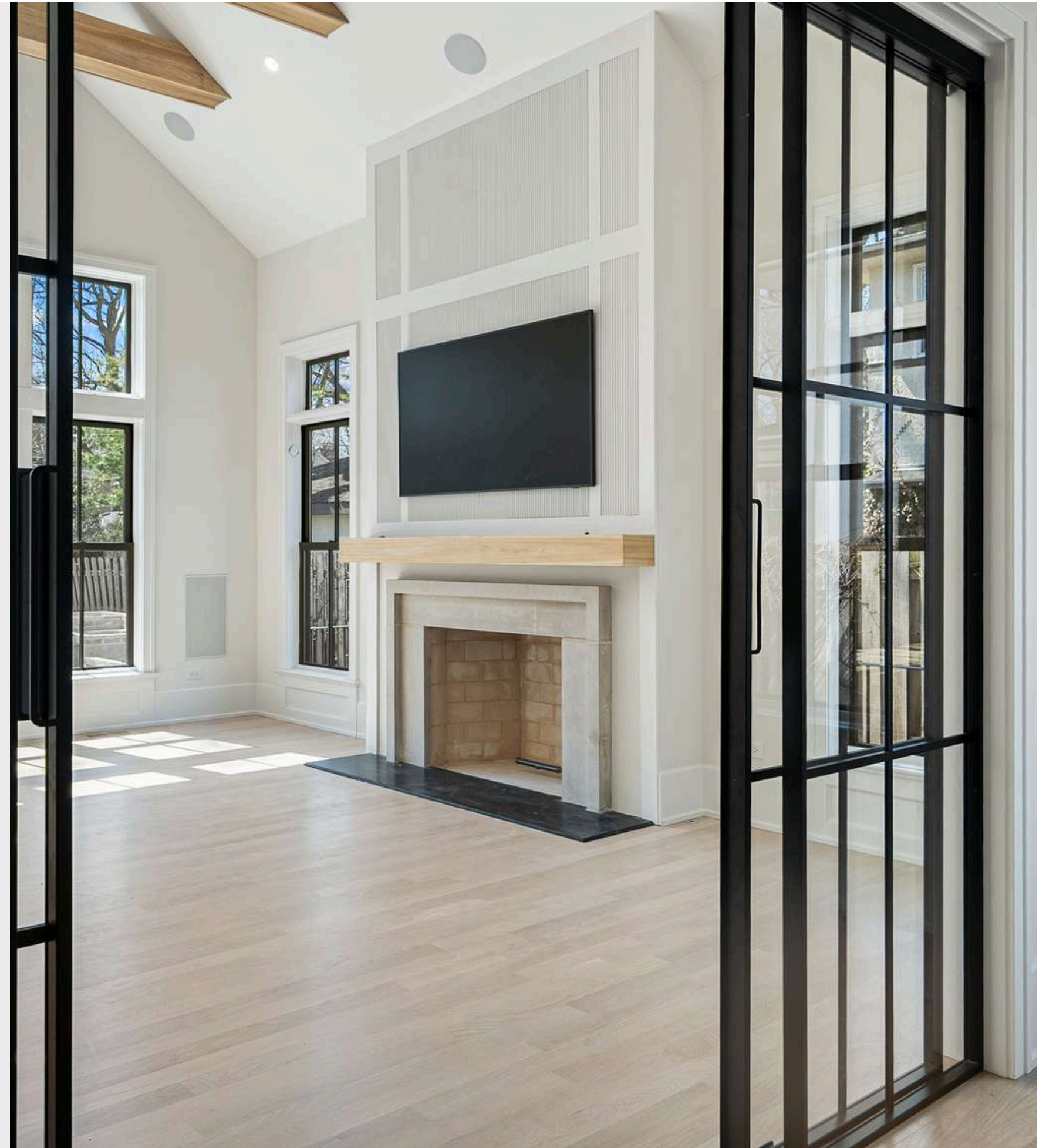

Loft Slim Sliding Doors

The Loft Slim sliding doors collection was used here to create a corner partition, forming a sliding wall that separates the home office area.

A multi-rail system allows all three panels to slide to one side, opening up the space when needed.

Sliding Doors Track & Pane options

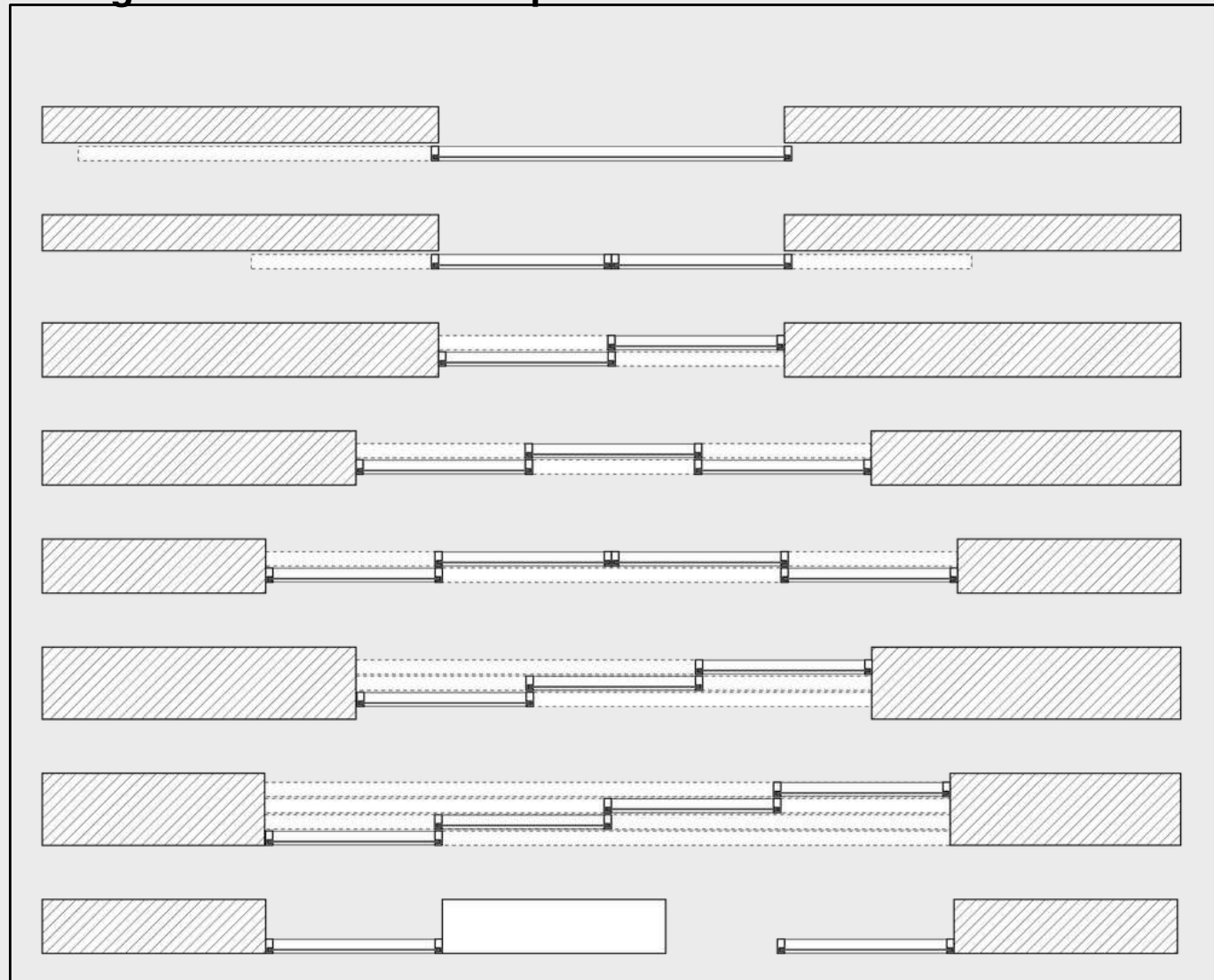

Loft Slim Slide + Fixed Panels

The Icon Loft Slim fixed panel system is defined by its minimalist lines and ultra-slim steel profiles, designed to create clear and elegant divisions within a space.

With no need for moving parts, fixed panels offer a practical way to build partition walls or separate zones while maintaining openness and light flow.

Thanks to the refined geometry and flexibility of the system, panels can be used alone or in combination with hinged, sliding, or pivot doors to form complete steel and glass installations.

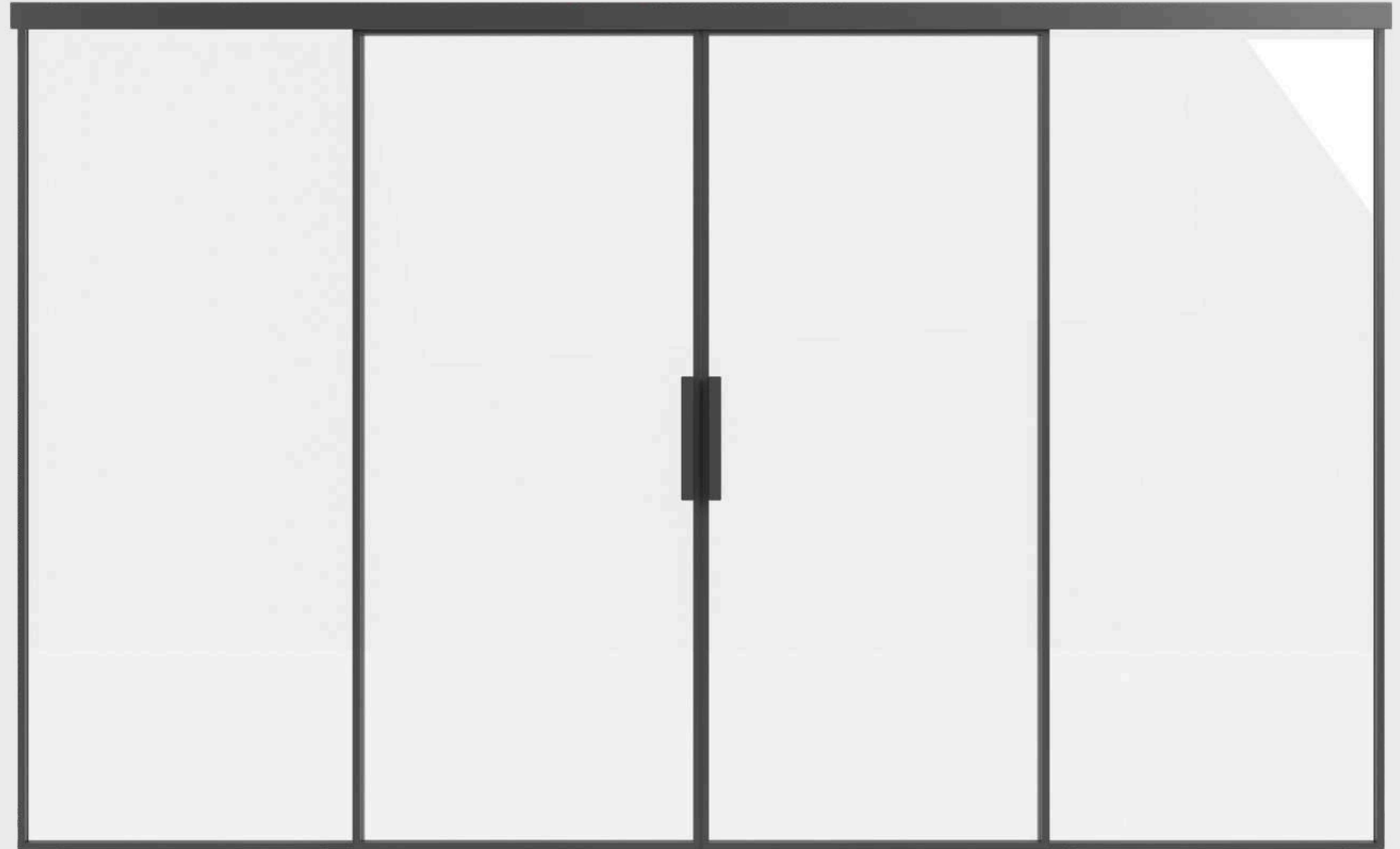

Fabrication limits:

	min	max
door leaf width [mm]	550	1500
door leaf width [mm]	1800	4000

Loft Slim Sliding Doors Installation Details

Slide w/ fixed panel details



Slide details



Slide w/ fixed panel details

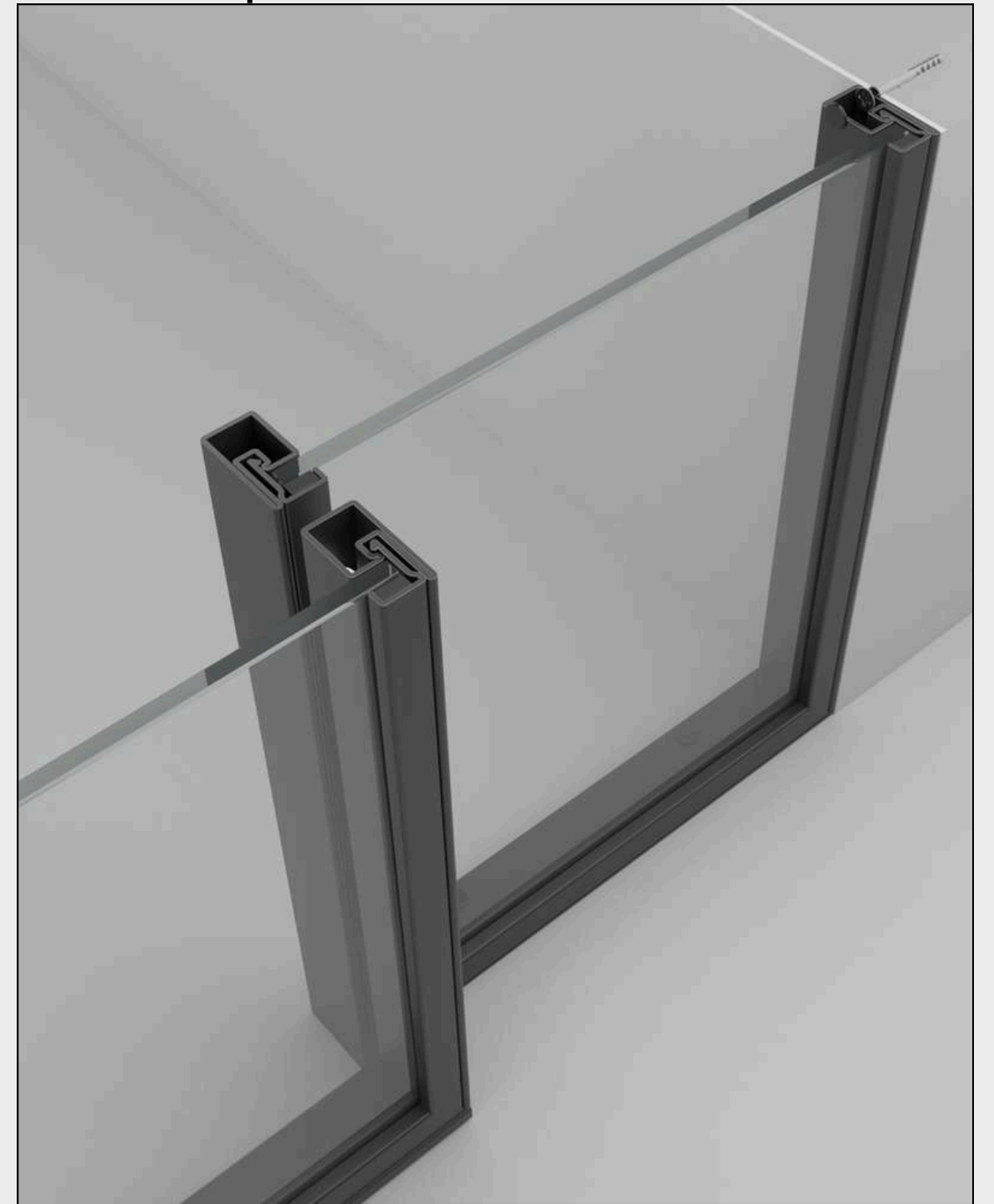

Loft Slim pivot doors

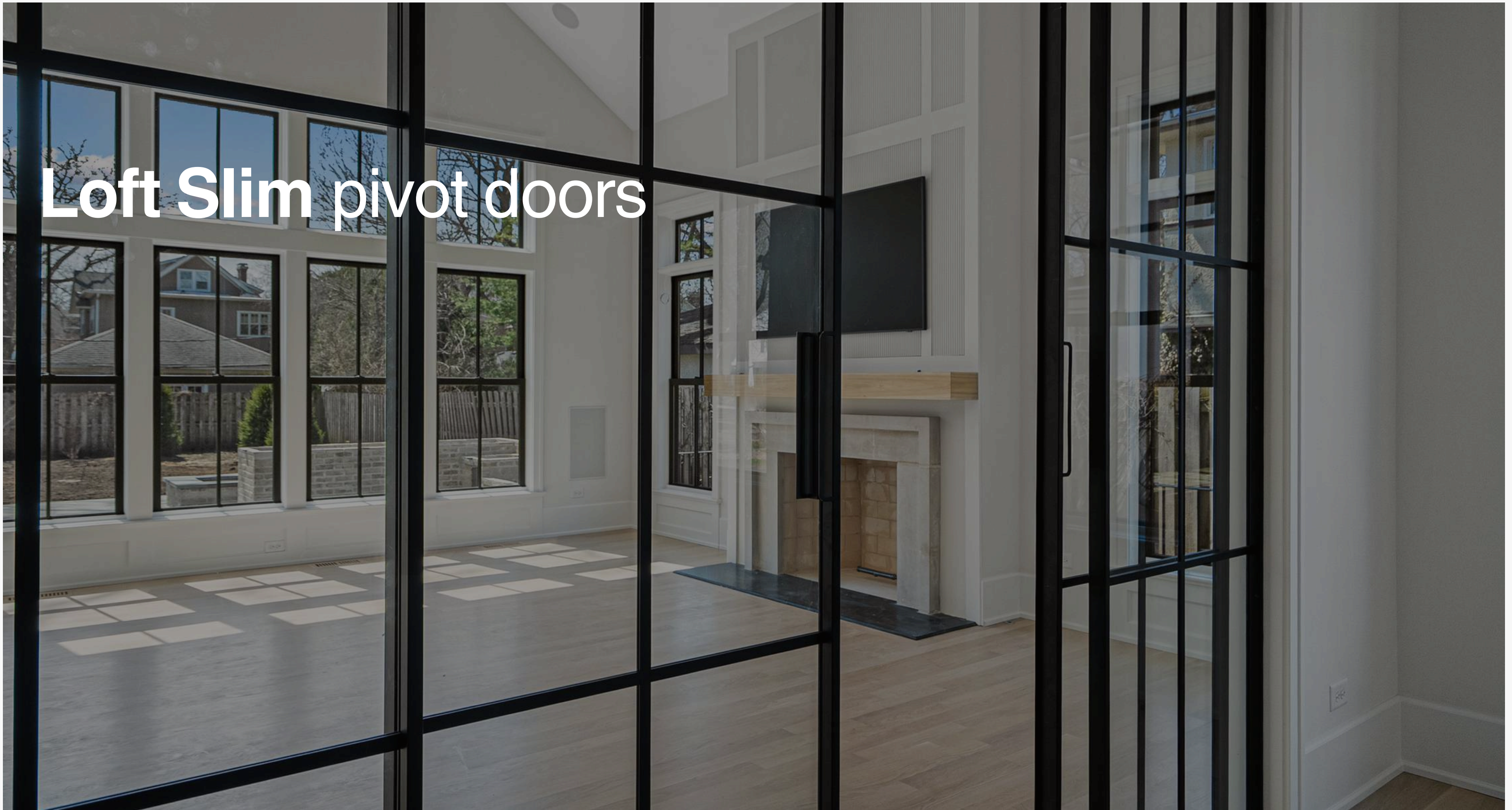

Loft Slim Pivot Doors

Icon Loft Slim pivot doors offer a 180° working range and soft closing for smooth, elegant operation.

We use Argenta Pivotica hinges in standard configurations and FritzJurgens systems for premium applications.

Available in single or double doors, with pivot axis positioned on the side or shifted toward the center.

Designed for easy and efficient installation.

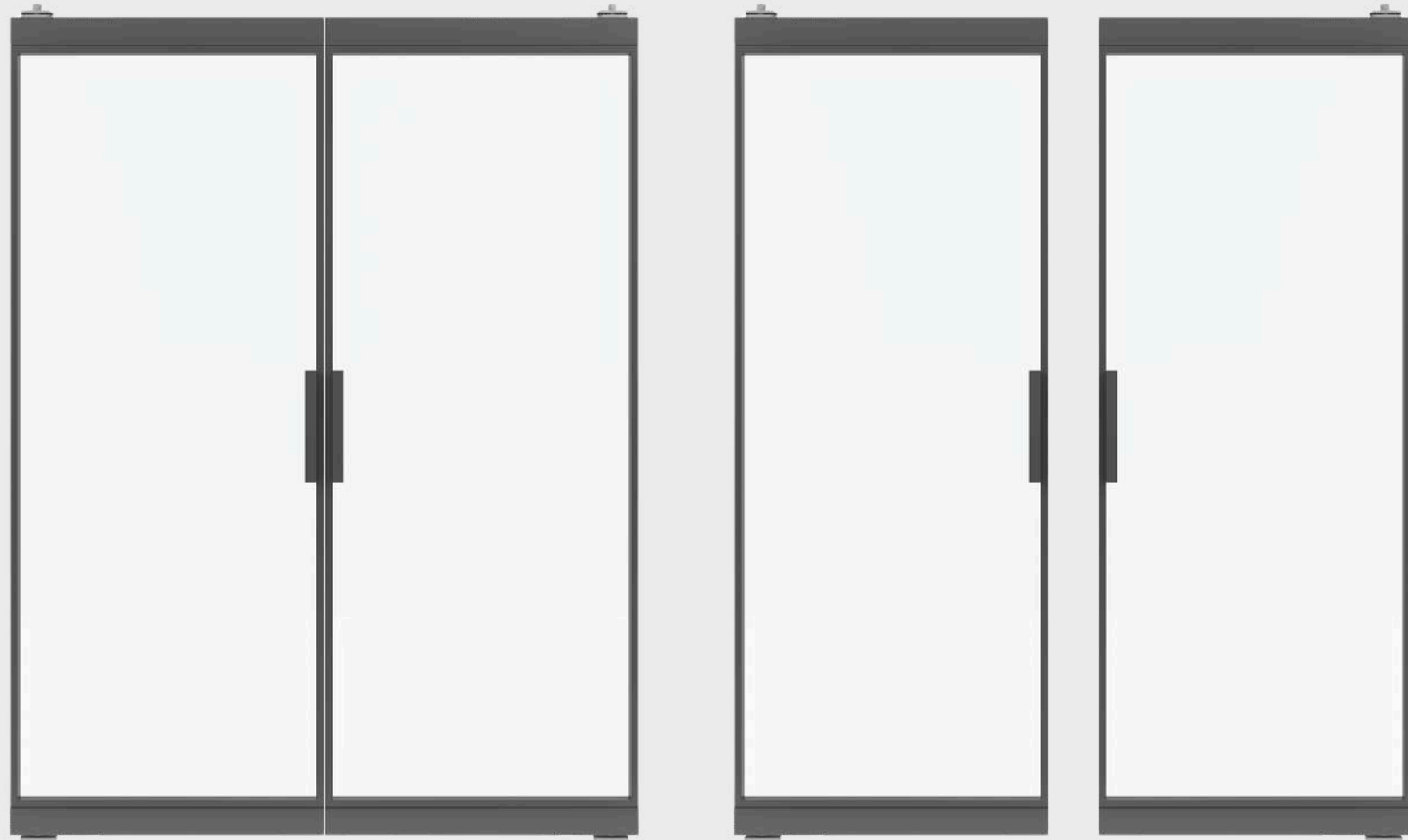

Loft Slim Pivot Doors

Pivot Doors Opening Options

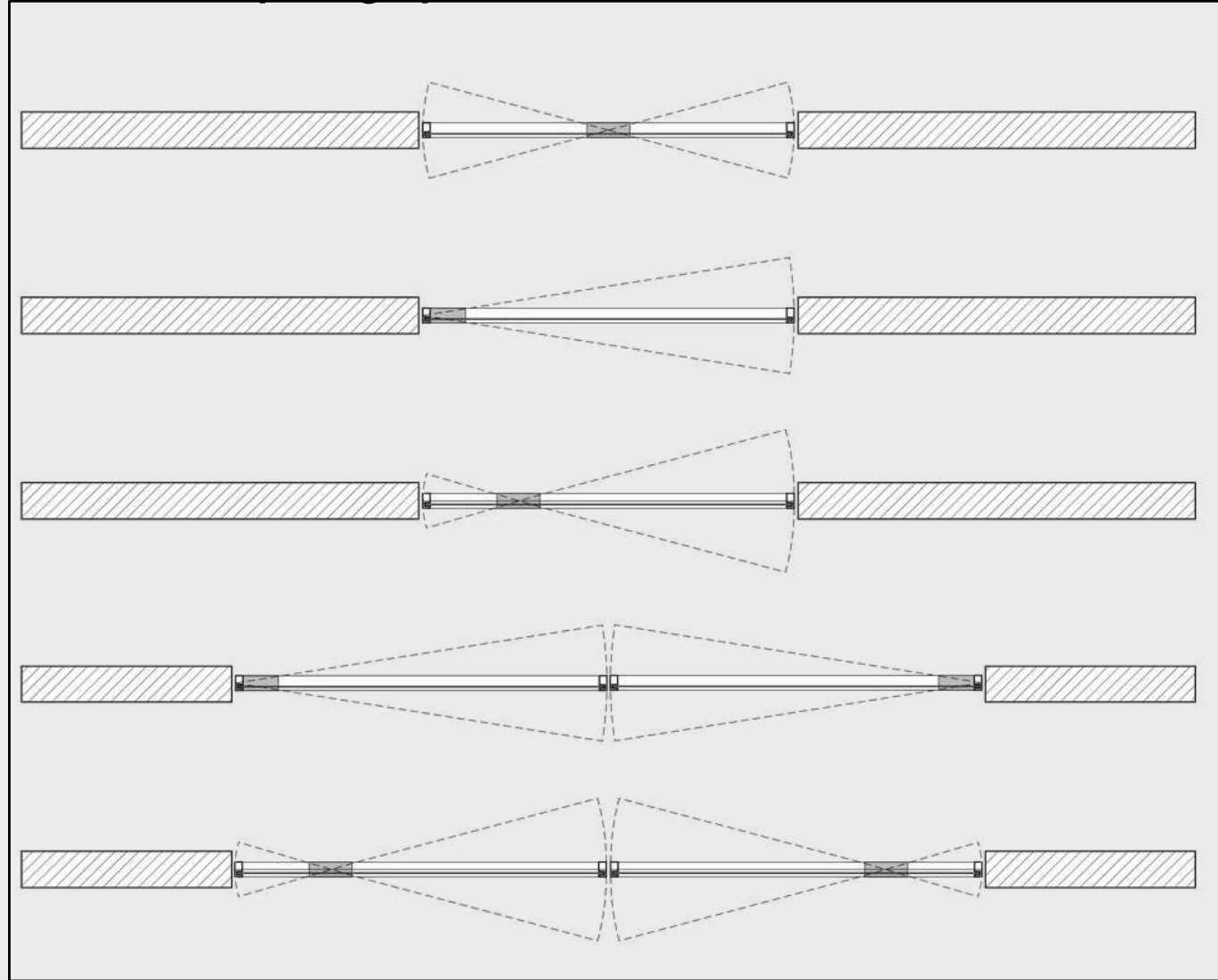

Pivot Doors Details



Pivot Hinge Details



Fabrication limits:

	min	max
door leaf width [mm]	550	1500
door leaf width [mm]	1800	4000

Loft Slim Pivot + Fixed Panels

Icon Loft Slim Pivot Doors combine modern design with flexible configuration. The system allows you to add fixed panels on the sides or above the door, creating larger glazed compositions that bring more light into the space. This makes pivot doors not only a functional entry solution but also a striking architectural element that can be tailored to individual interiors.

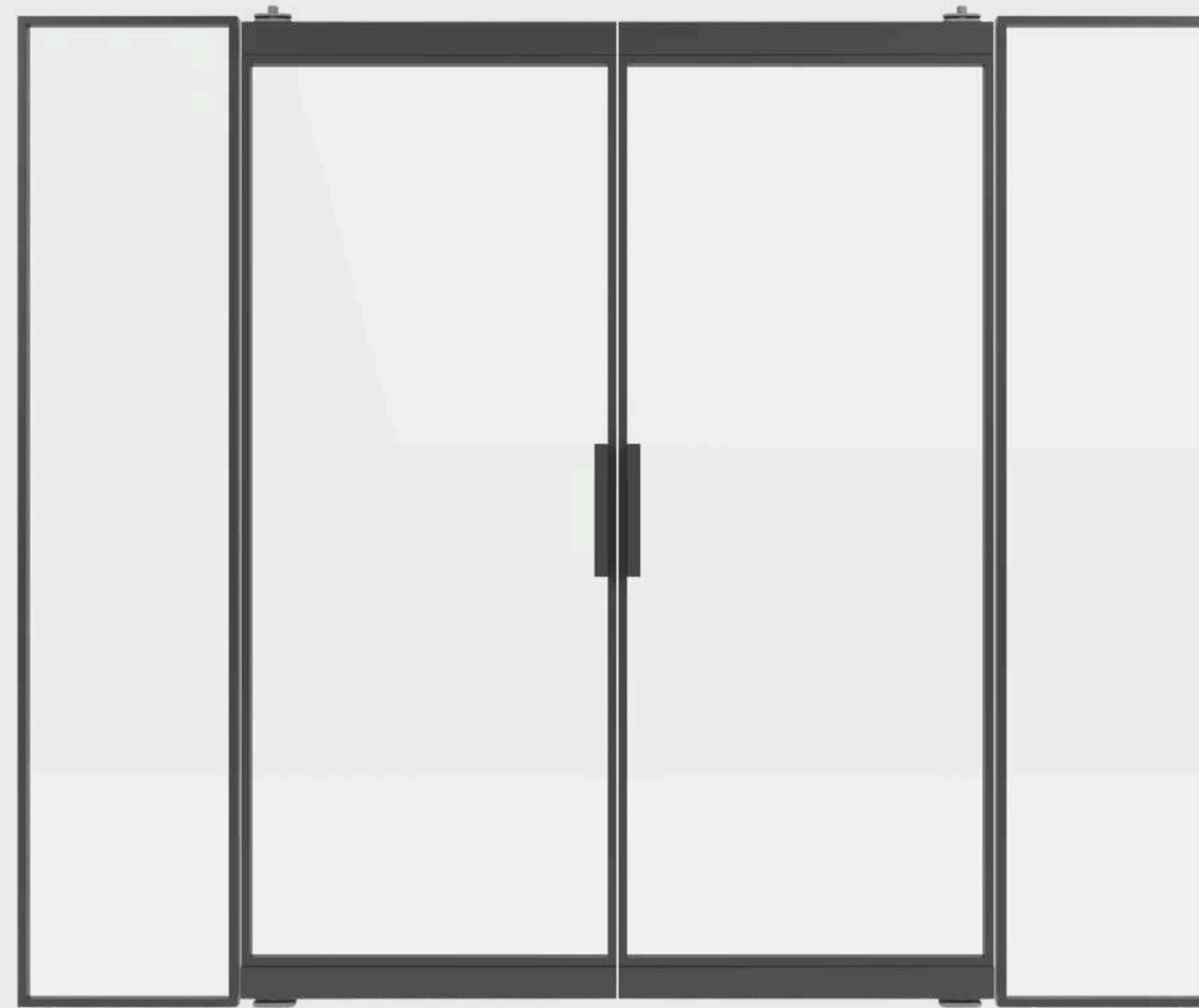

Fabrication limits:

	min	max
door leaf width [mm]	550	1500
door leaf height [mm]	1800	4000

Pivot Doors with Fixed Panel Details



Loft Slim Pivot Doors Installation Details

Pivot Doors Installation Details

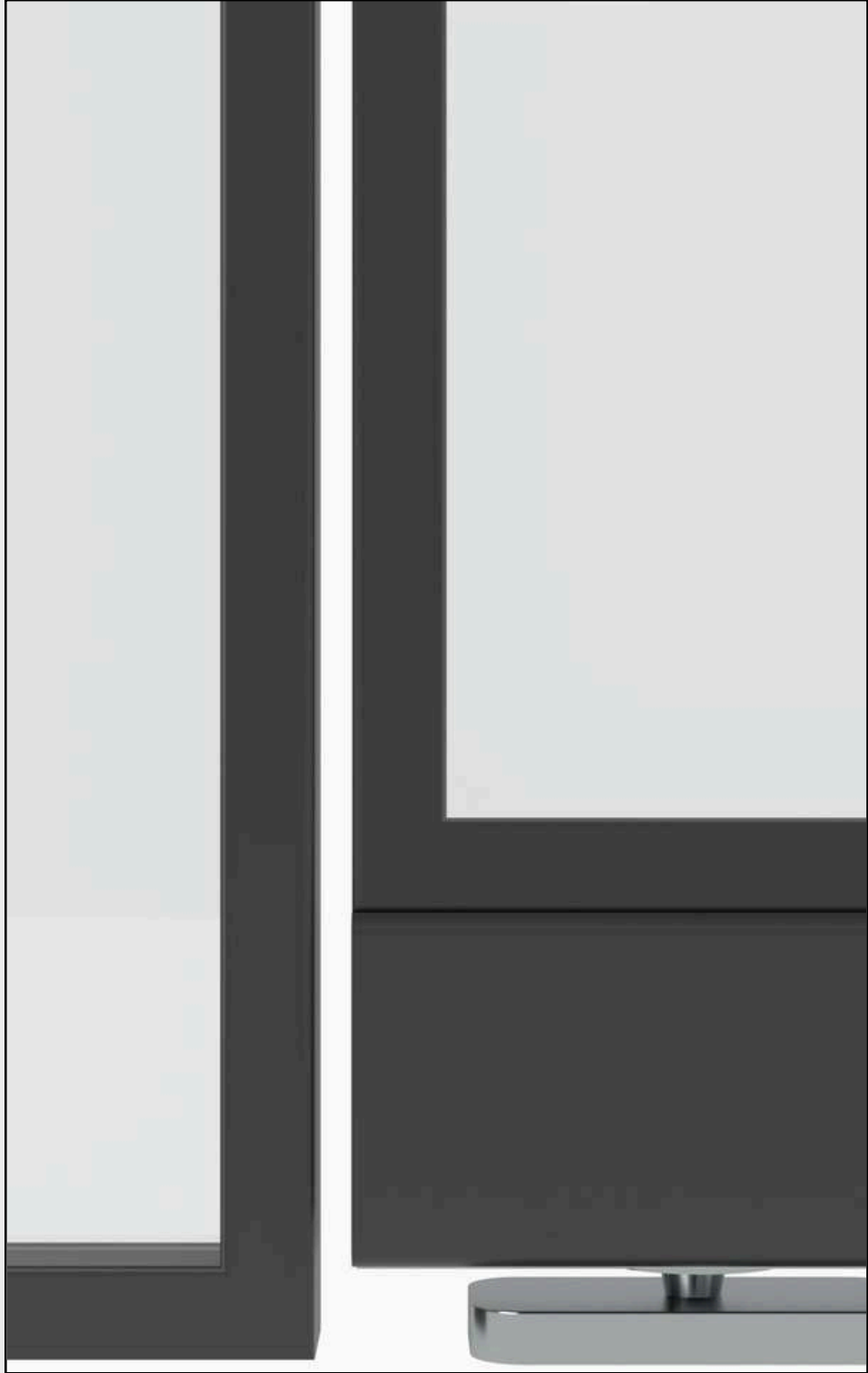

Pivot Doors Installation Details



Pivot Doors Installation Details



Loft Slim bi-folding doors



Loft Slim Bi-folding doors

Icon Loft Slim bifolding doors offer a space-saving solution with clean, modern lines.

Available in configurations up to 6 panels.

Choose between top rail only or top + bottom rail systems, depending on your project needs.

Ideal for maximizing open space while maintaining a strong visual presence.

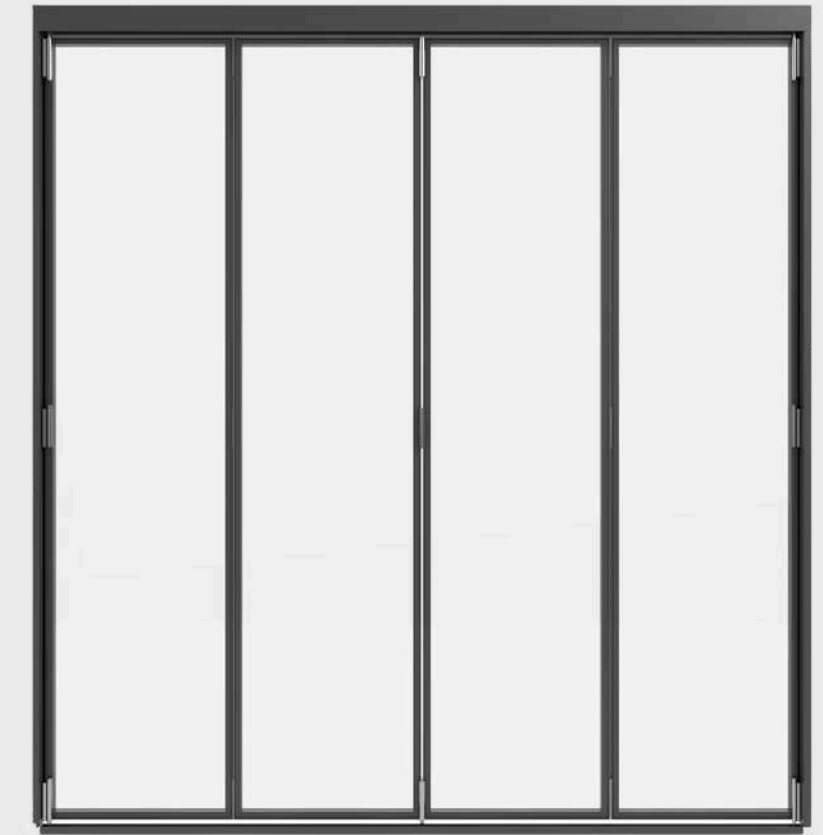
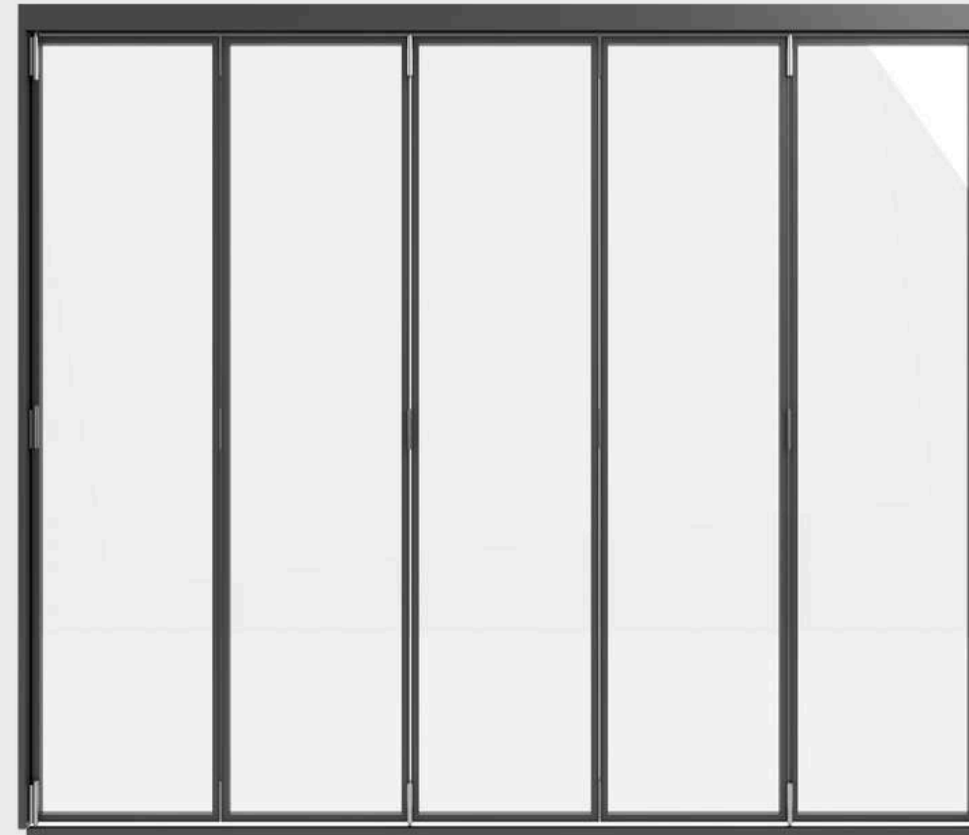

Fabrication limits:

	min	max
door leaf width [mm]	550	1500
door leaf width [mm]	1800	4000

Bi-folding Doors Opening Options

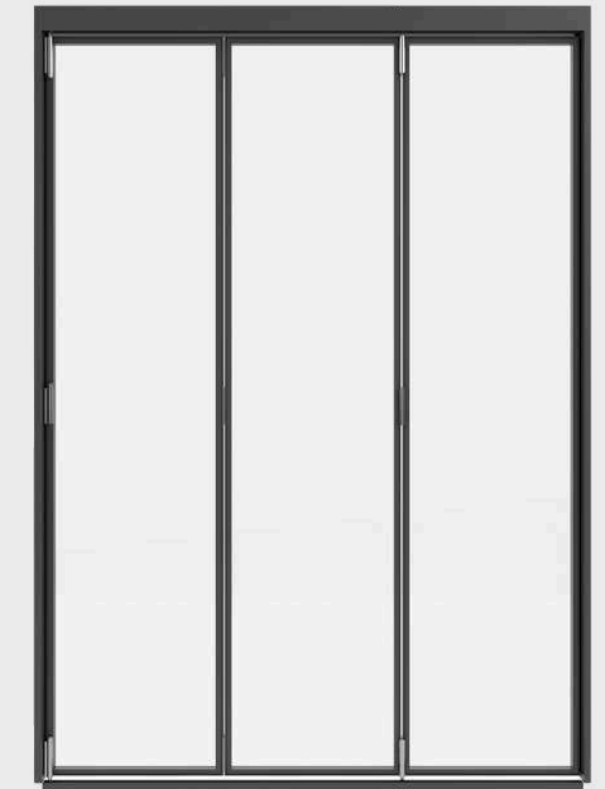
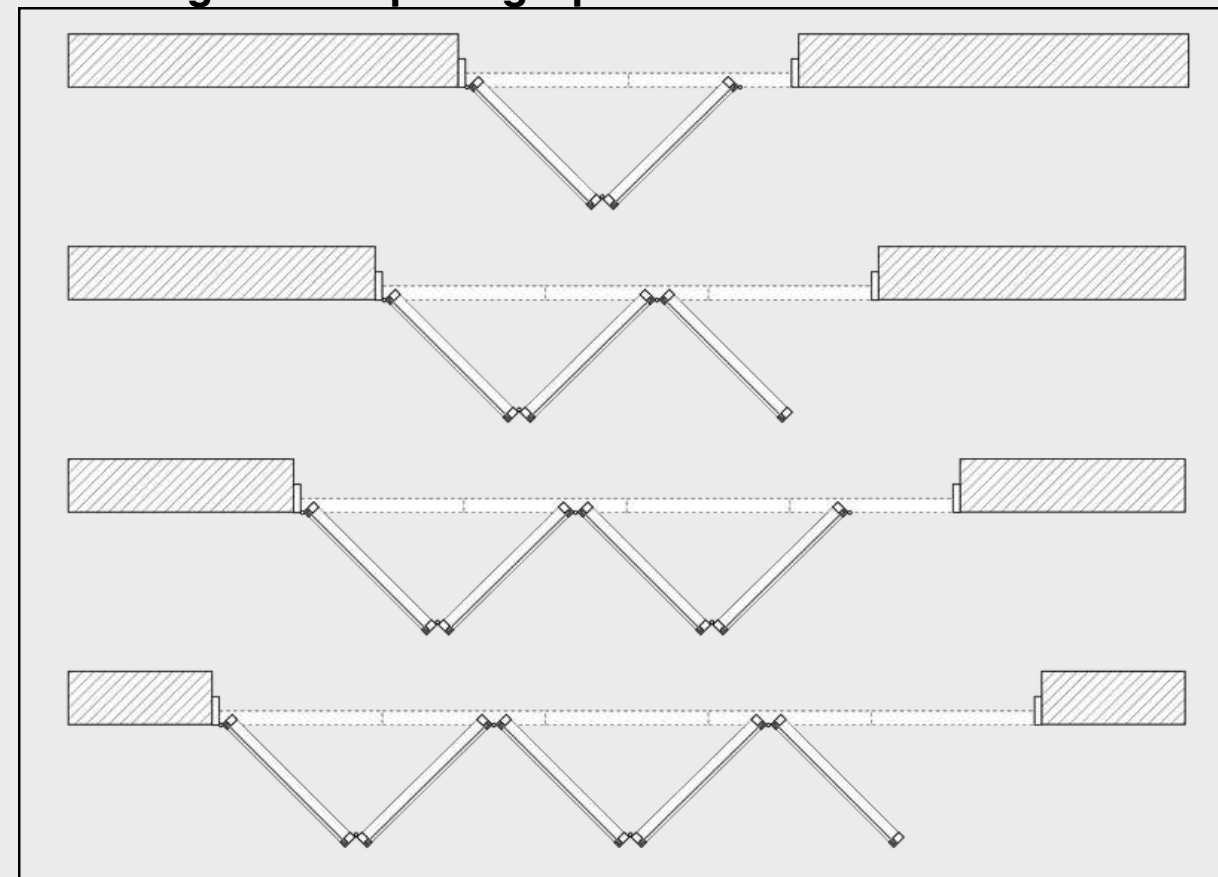

Loft Slim fixed panels



Loft Slim Fixed Panels

The Icon Loft Slim fixed panel system is defined by its minimalist lines and ultra-slim steel profiles, designed to create clear and elegant divisions within a space.

With no need for moving parts, fixed panels offer a practical way to build partition walls or separate zones while maintaining openness and light flow.

Thanks to the refined geometry and flexibility of the system, panels can be used alone or in combination with hinged, sliding, or pivot doors to form complete steel and glass installations.

Fabrication limits:

	min	max
door leaf width [mm]	550	1500
door leaf width [mm]	1800	4000





Loft Slim customization options

Loft Slim Bar types

Icon Loft Slim offers several options for division bars, allowing you to tailor the look of each door or partition. Stick-on bars are made from a special aluminum profile with hidden glue and tape, ensuring a clean surface with no visible fixings. For a more traditional solution, you can choose welded bars combined with aluminum, giving a solid and permanent effect. Another option is stick-on steel bars, which make it possible to create arched and custom shapes, adding distinctive character to the design.

Stick-on aluminum bar



Welded steel bar + aluminum stick-on bar



Loft Slim Bars Layouts



premium design code 001

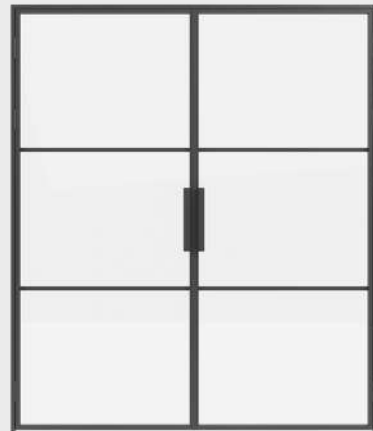

premium design code 004

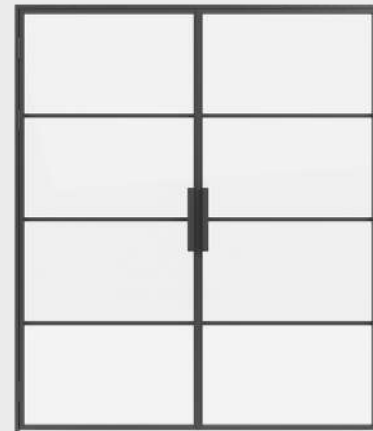

premium design code 005

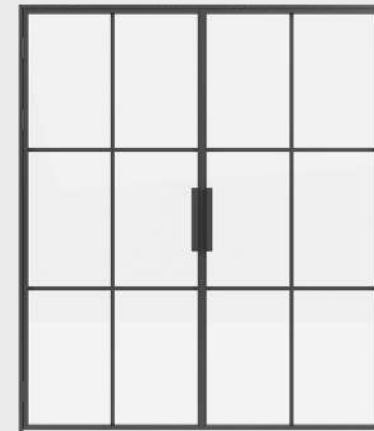

premium design code 018

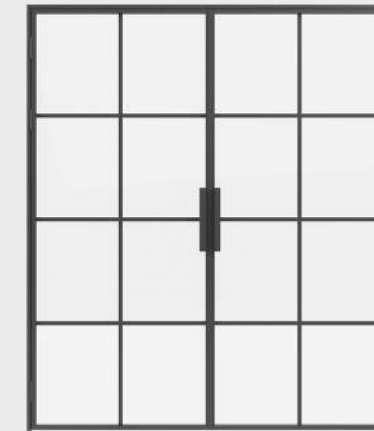

premium design code 006

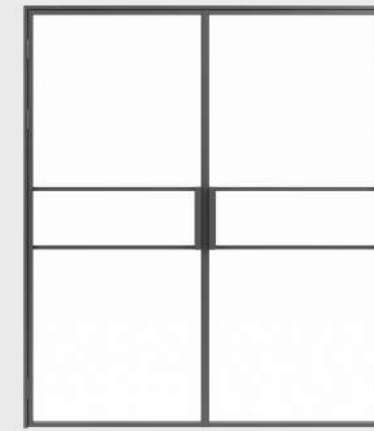

premium design code 002



premium design code 021

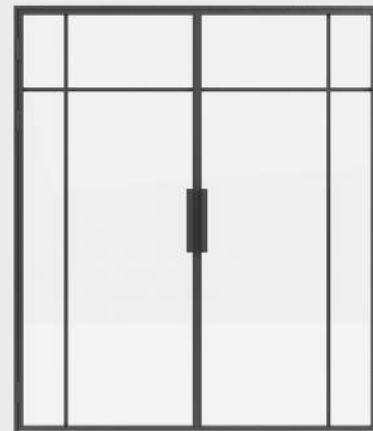

premium design code 022

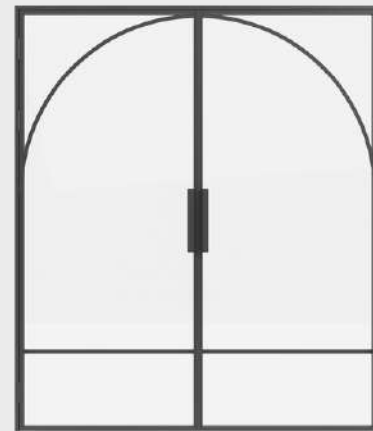

Custom Studio design code 020

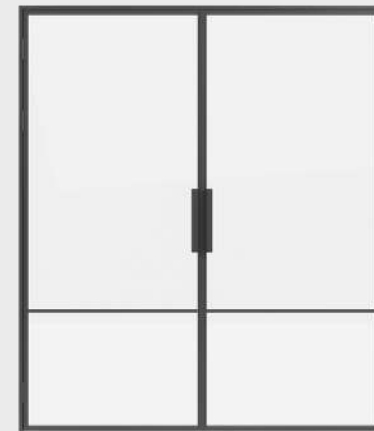

premium design code 023



premium design code 014

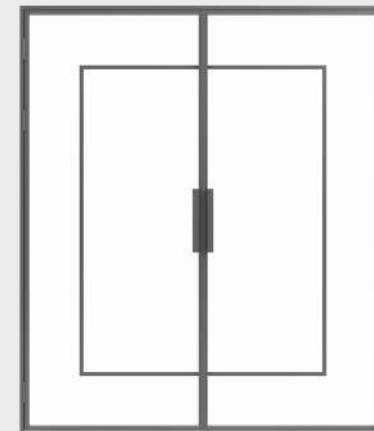

Custom Studio design code 015

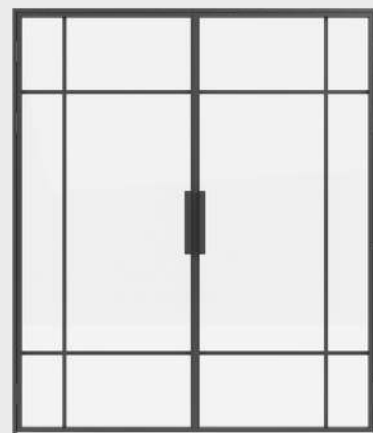

premium design code 008

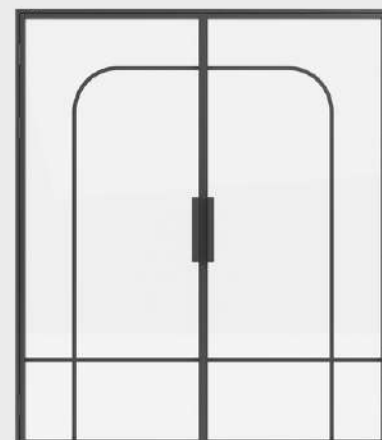

Custom Studio design code 030

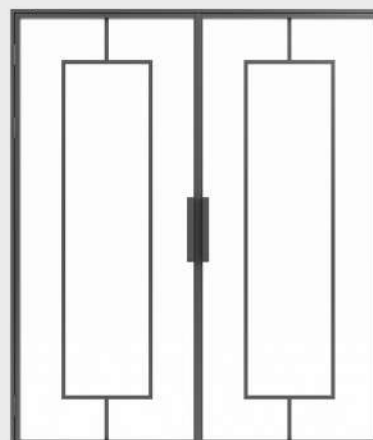

Custom Studio design code 007

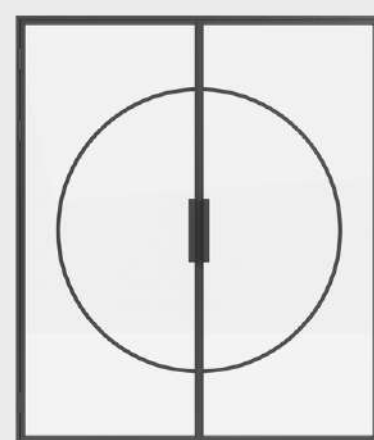

Custom Studio design code 010

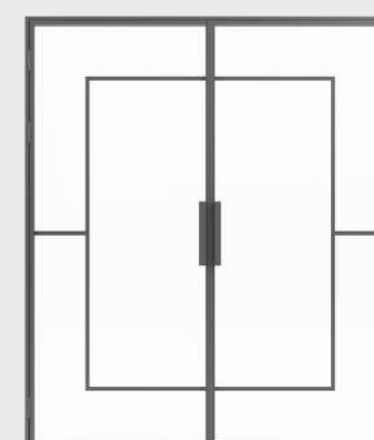

Custom Studio design code 012

Loft Slim + Fixed Panels

All Icon Loft Slim Doors are fully compatible with fixed panels, allowing you to extend the system beyond a single door. Fixed panels can be square, triangular, or arched, giving architects and designers freedom to create unique layouts that match the character of the space. This flexibility makes it possible to design both simple partitions and striking architectural features with the same slim profile system.

Fabrication limits:

	min	max
door leaf width [mm]	550	1500
door leaf height [mm]	1800	4000

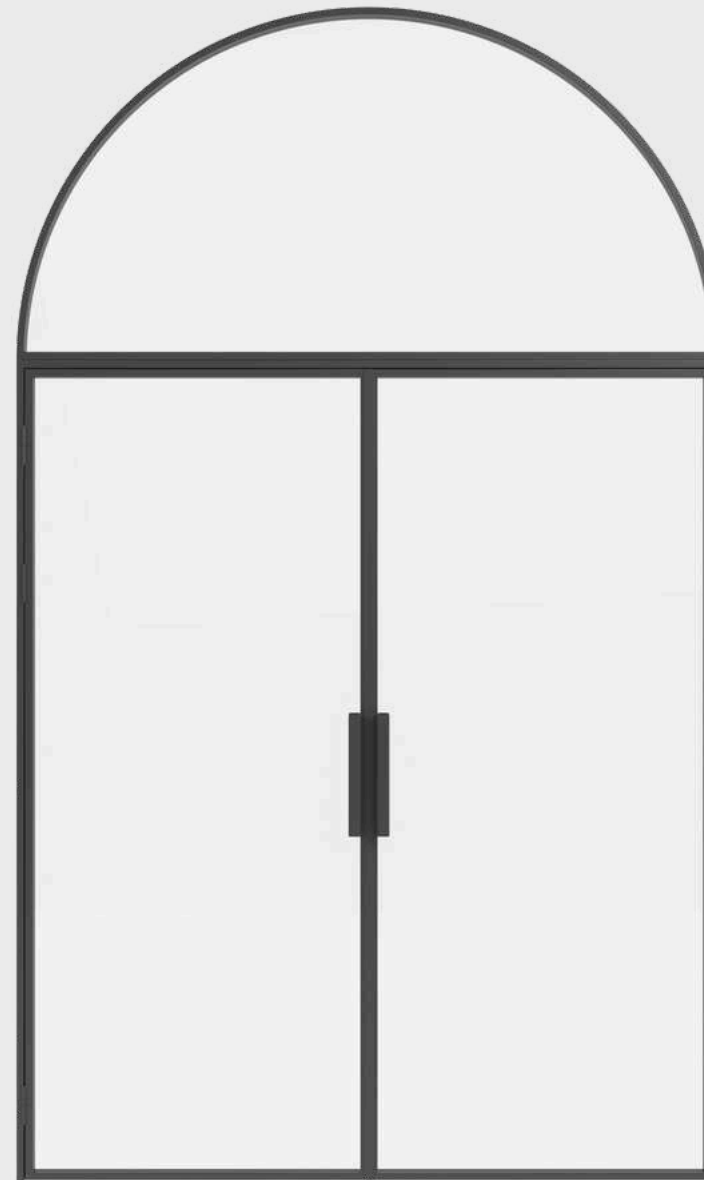

Arched panel details

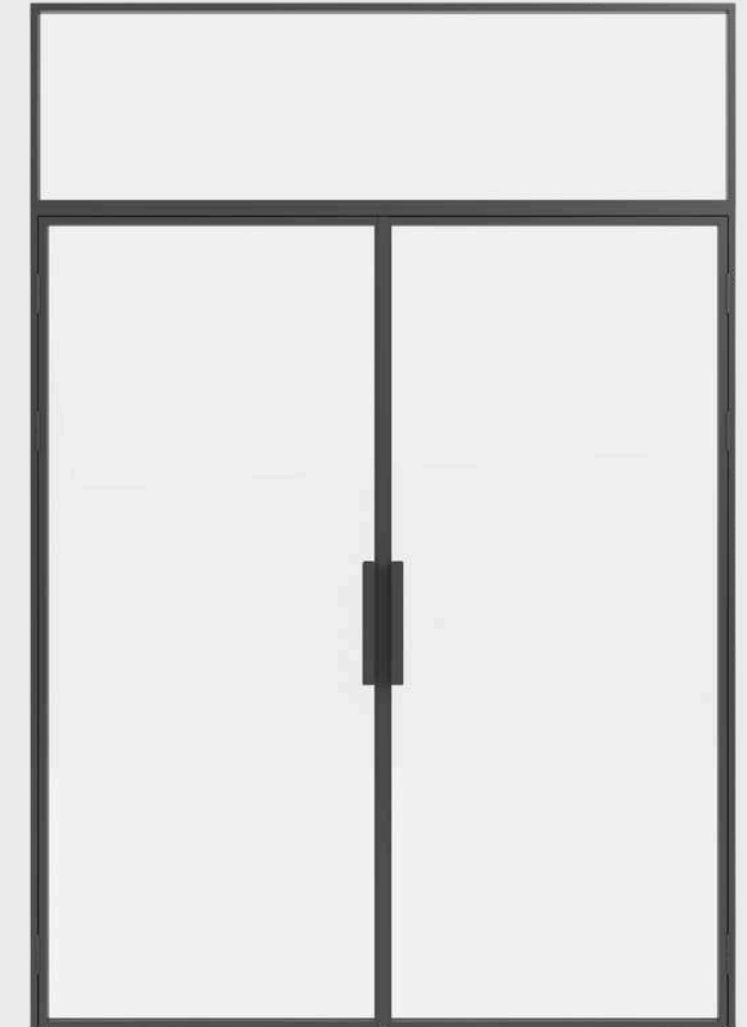

Standard panel details



Loft Slim Kickpanels

Kick Panels are protective steel plates mounted directly on the door surface. Made from 100% steel and finished with durable powder coating, they combine strength with a clean look. The dimensions are fully customizable, allowing the panel to be adapted to any project requirements while ensuring long-lasting protection in high-traffic areas.

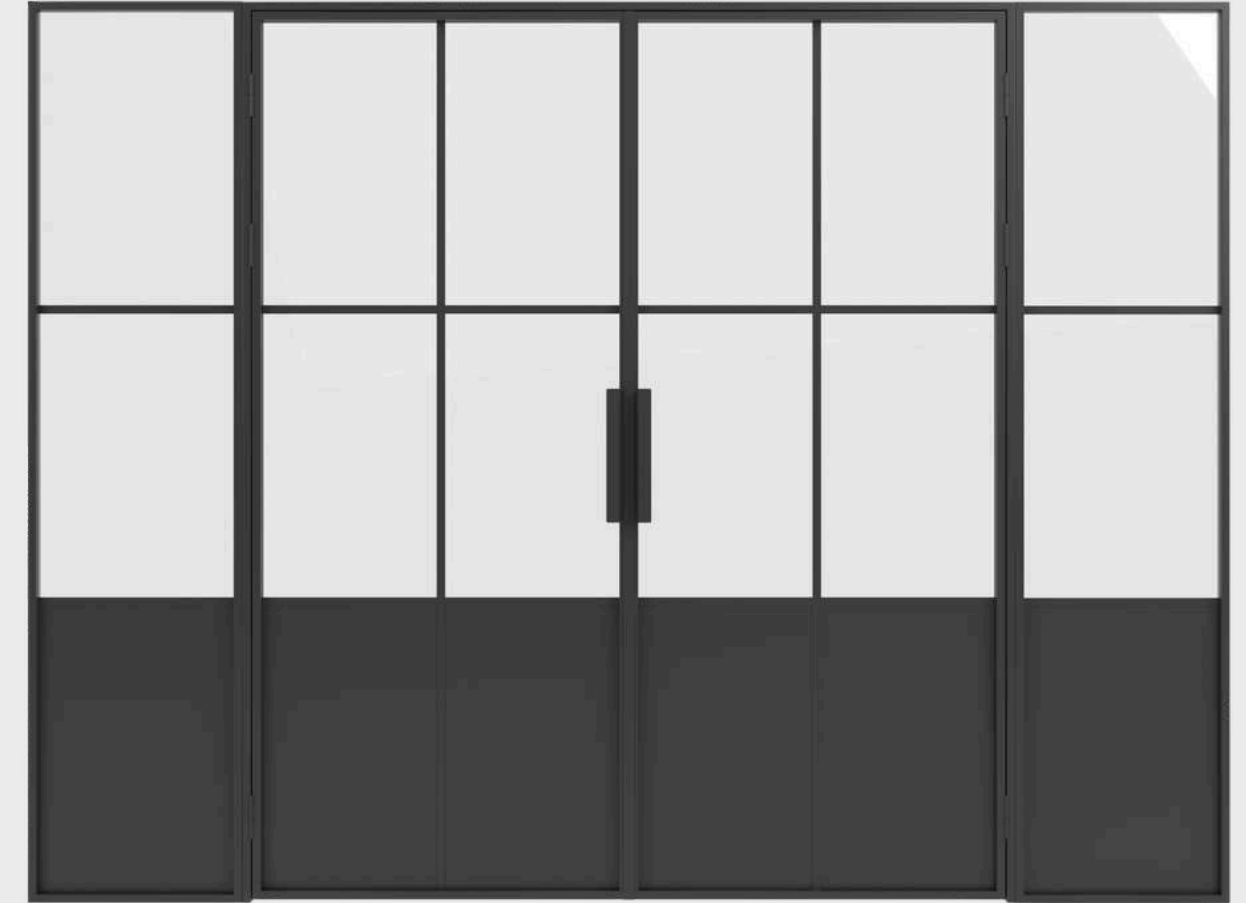
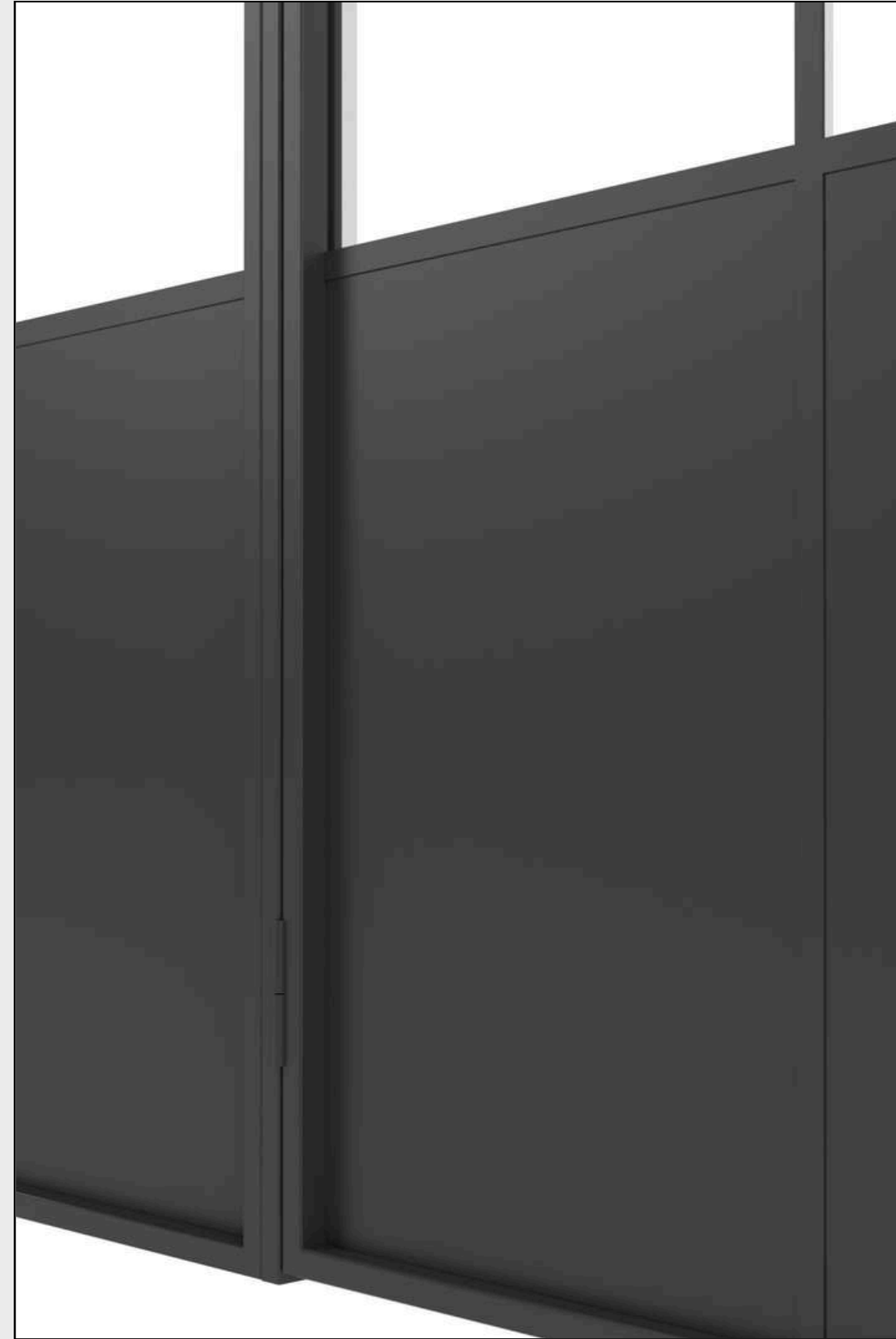

Loft Slim Arched Elements

Loft Slim Arched Elements add a distinctive architectural touch to the system. They can be designed as arched door leaves, fixed partitions, or fixed panels placed above doors. This allows for elegant curves that soften the geometry of steel frames while maintaining the slim profile look. Radius limits apply and are defined individually for each project, ensuring both aesthetics and structural reliability.

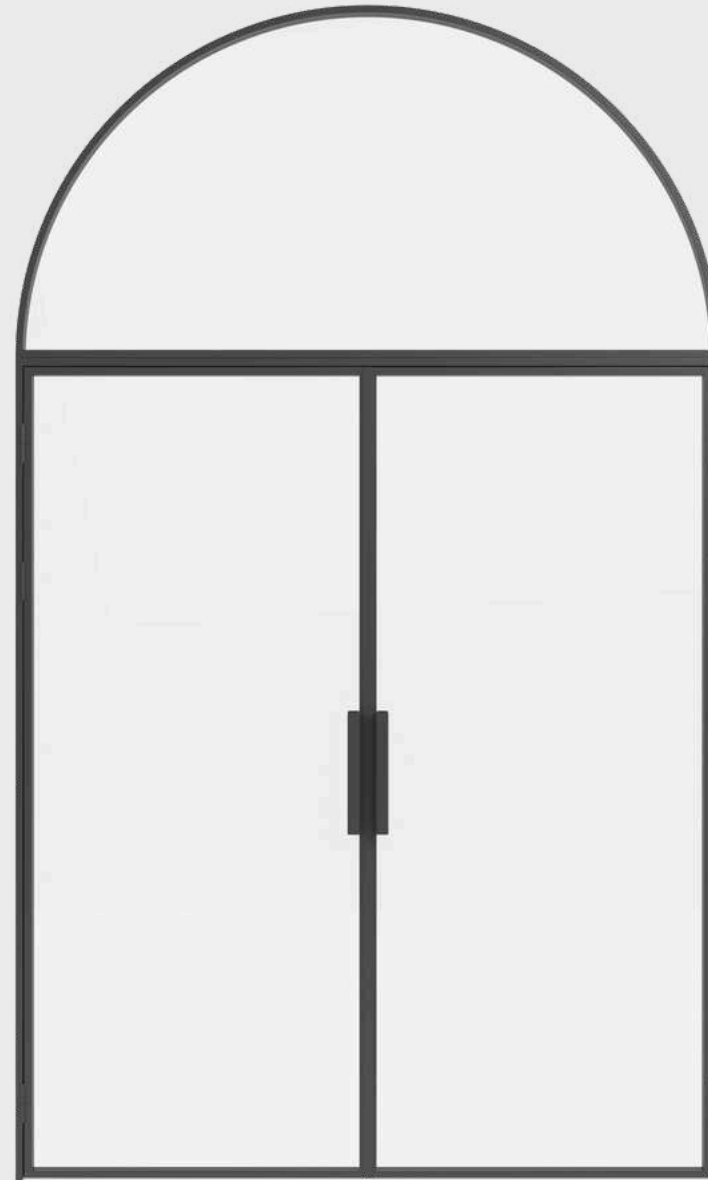

Fabrication limits:

	min	max
door leaf width [mm]	550	1500
door leaf width [mm]	1800	4000

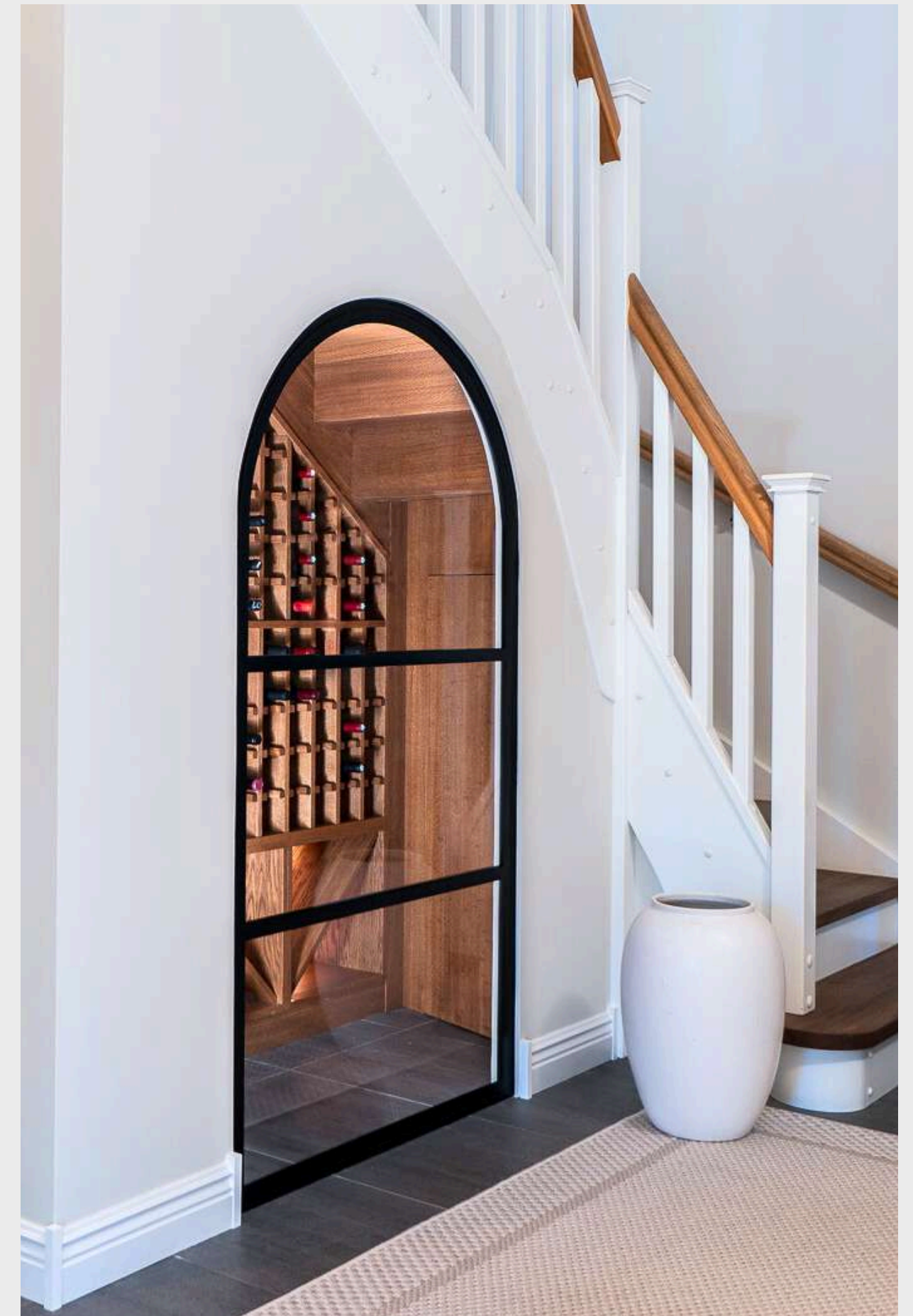

Loft Slim Lock cassettes

Icon Loft Slim Lock Cassettes are steel components designed to house locks within the system. They are available in both standard and custom versions. The standard cassette comes in fixed dimensions, while the custom option allows for full flexibility — for example, aligning the cassette precisely with division bars or adapting its size to a specific design layout. This ensures a seamless look without compromising functionality.

Standard lock-cassette dimensions

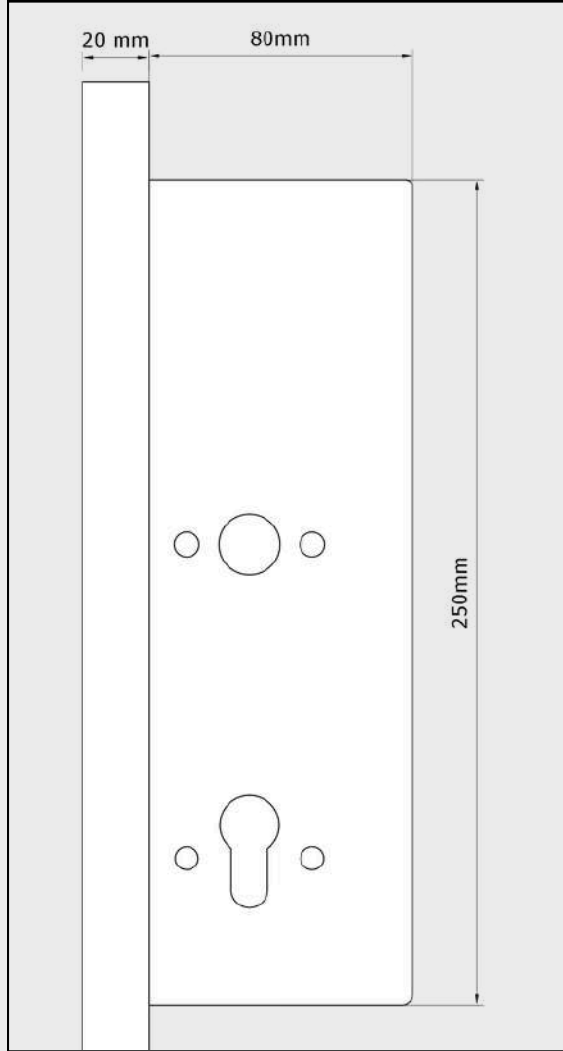

Standard lock-cassette



Custom lock-cassette



Loft Slim Pull handles

Icon Loft Slim Pull Handles come included in the price of the system and are paired with a magnetic closing mechanism for everyday convenience. Only premium handle models are available at an additional cost. Selected handle types can also be made in custom dimensions, allowing the design to be tailored to the proportions of the door or the client's individual preferences.

Pull handle 1

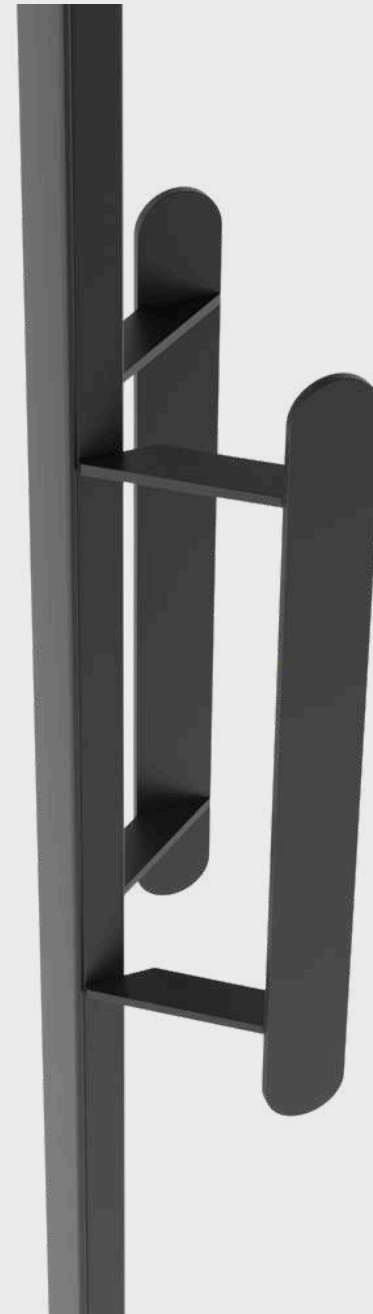

Pull handle 2

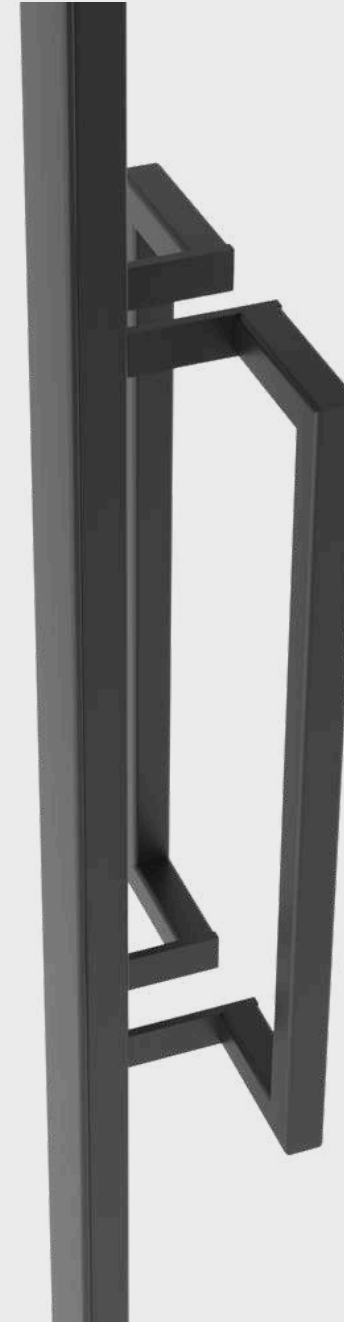

Pull handle 2.1

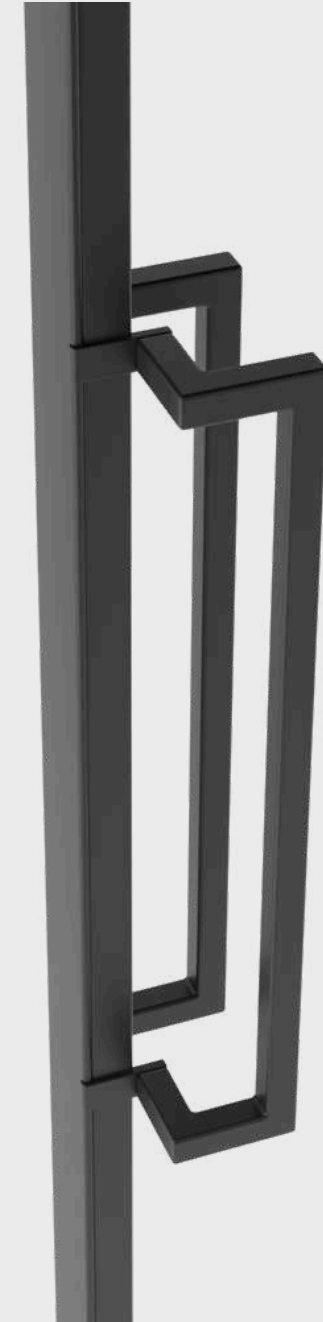

Loft Slim Pull handles

Icon Loft Slim Pull Handles come included in the price of the system and are paired with a magnetic closing mechanism for everyday convenience. Only premium handle models are available at an additional cost. Selected handle types can also be made in custom dimensions, allowing the design to be tailored to the proportions of the door or the client's individual preferences.

Pull handle 3.0 A



Pull handle 3.0 B



Pull handle 3.0

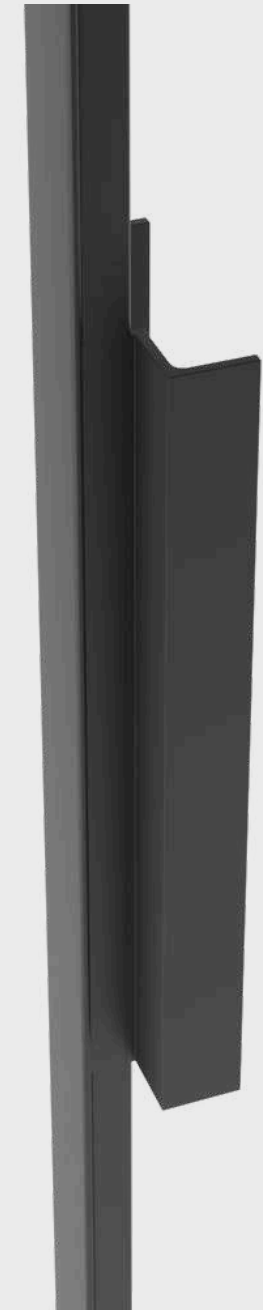

Loft Slim Pull handles

Pull handle Deco Brass



Pull handle 5.1

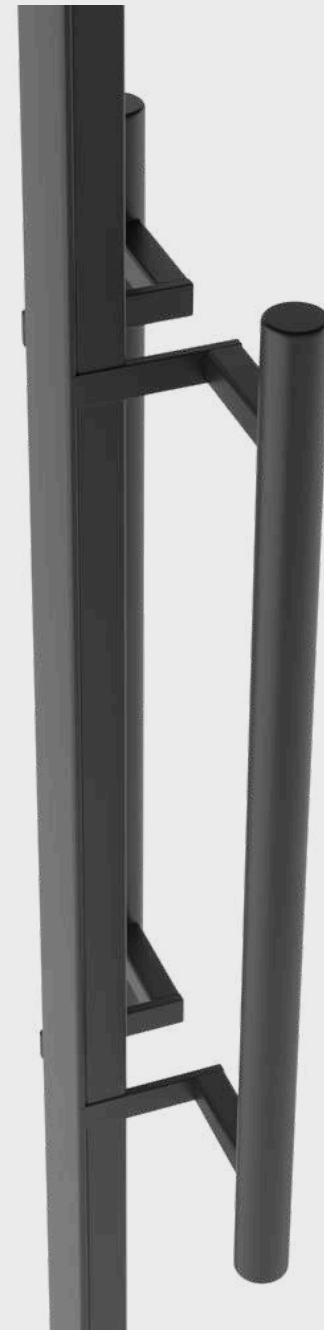

Pull handle 5.2



Loft Slim Pull handles

Pull handle 6.0



Pull handle 6.1



Pull handle for pocket doors



Loft Slim Hammered Collection

Hammered Collection Pull Handles are handcrafted by artisans, featuring a distinctive ridged or hammered texture that gives each piece a unique character. Dimensions can be customized, and the handles are available in the same powder-coated colors as the door frames, ensuring a consistent and refined look across the entire project.

Hammered Pull handle

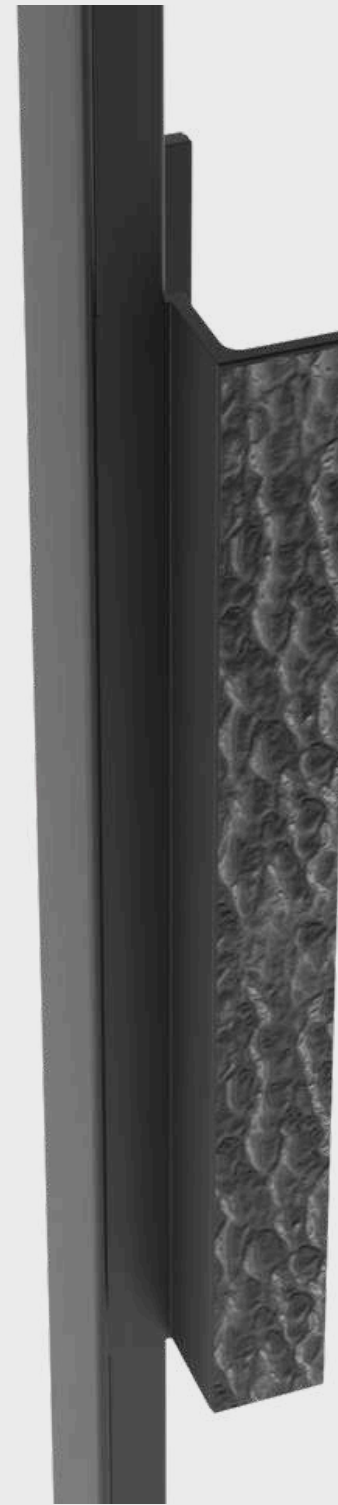

Ridged Pull handle



Loft Slim handles

Loft Slim Handles are high-quality handles designed primarily for private residential use. For commercial or high-traffic spaces, we also offer a professional range upon request, ensuring durability and performance tailored to more demanding environments.

NOVO HANDLE



TOP HANDLE



TIME GOLD HANDLE



TIME BLACK HANDLE



Loft Slim Accessories

Loft Slim Accessories complete the system with practical solutions for everyday use. The range includes toilet locks, door stops, shoot bolts for passive door leaves, and door closers. Each accessory is designed to integrate seamlessly with the Loft Slim system, combining functionality with the same clean, minimalist aesthetic.

WC LOCK



DOOR STOP



SHOOTBOLT



TIME BLACK HANDLE



Loft Slim Colors

Loft Slim Color Palette offers a wide choice of finishes to match any interior. The standard powder-coated palette is included in the price, while metallic finishes are available at an additional cost. For projects requiring unique solutions, other RAL colors and custom paints can also be provided, giving full freedom in design.

STANDARD PALETTE

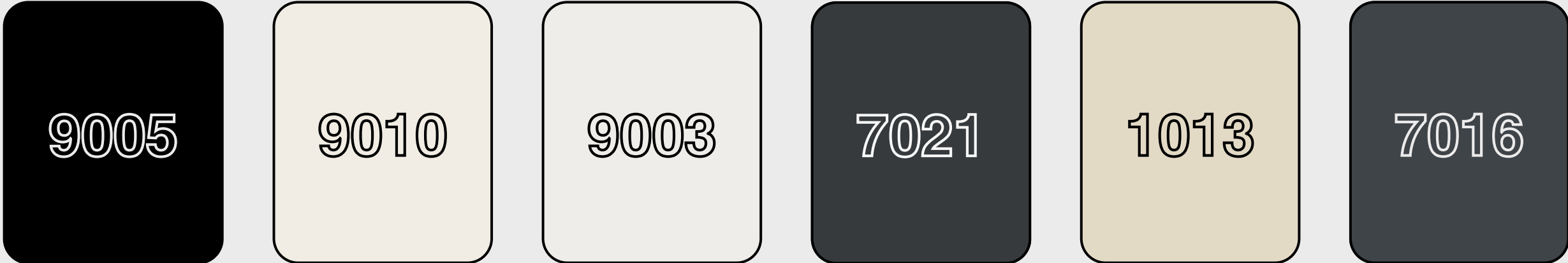

METALLIC PALETTE



Loft Slim Glass

CLEAR 6MM

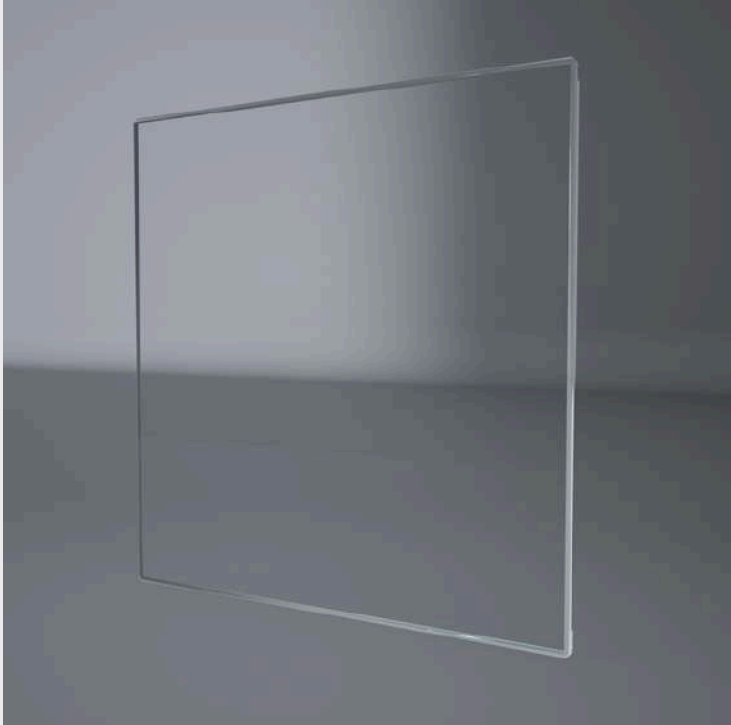

SATIN 6MM

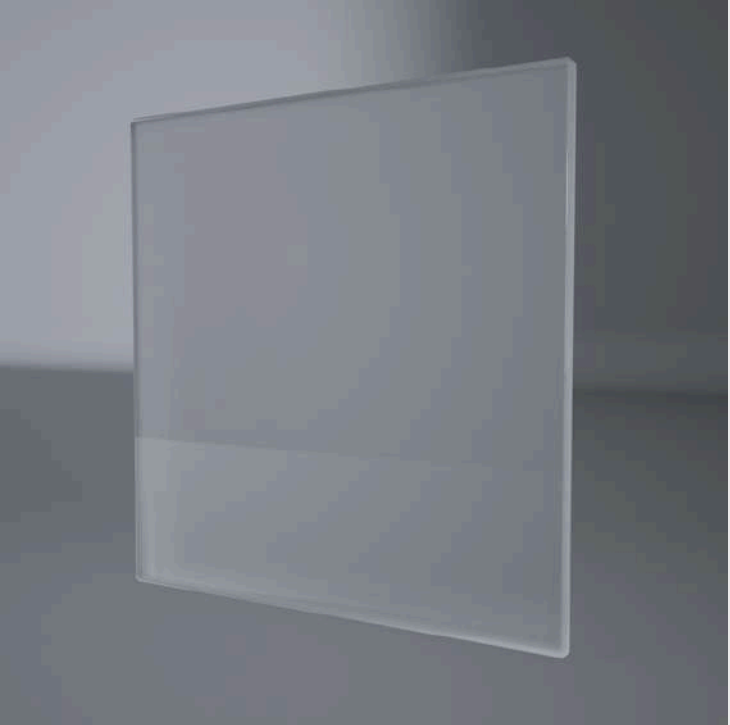

VISIOSUN

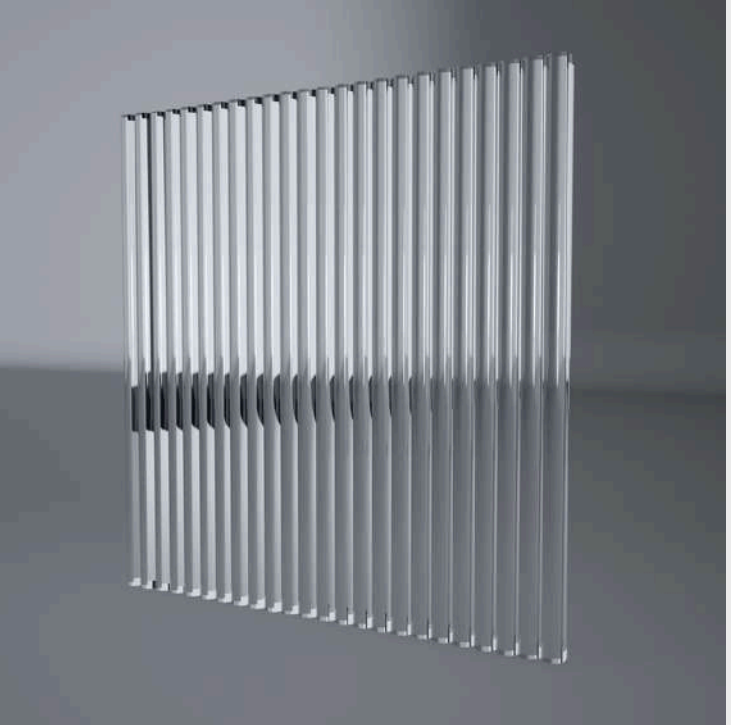

ANTISOL GRAPHITE

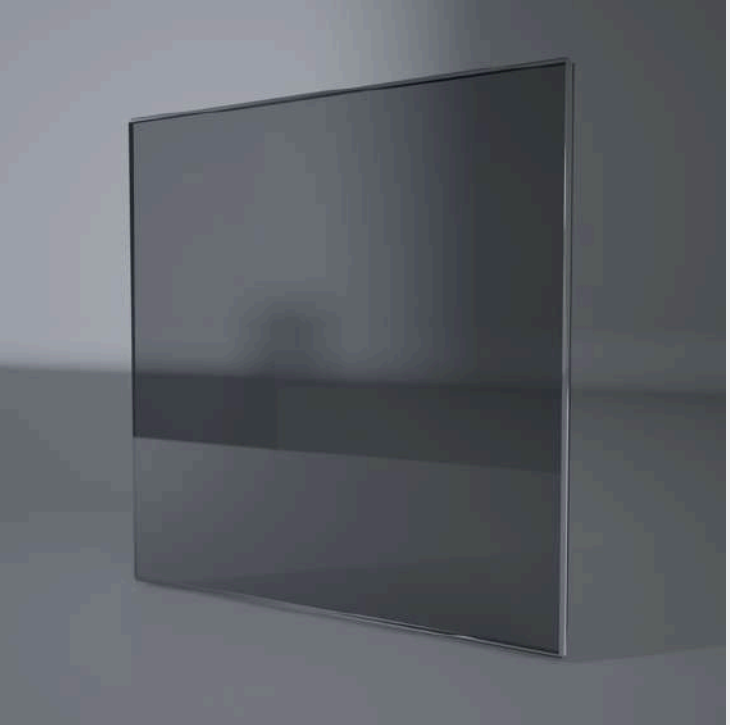

FLUTES

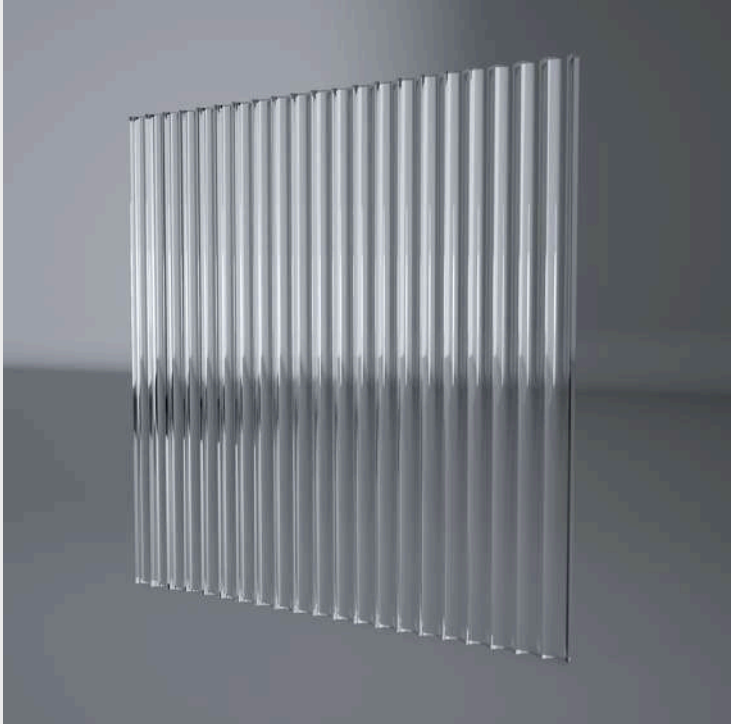

ESTRIADO

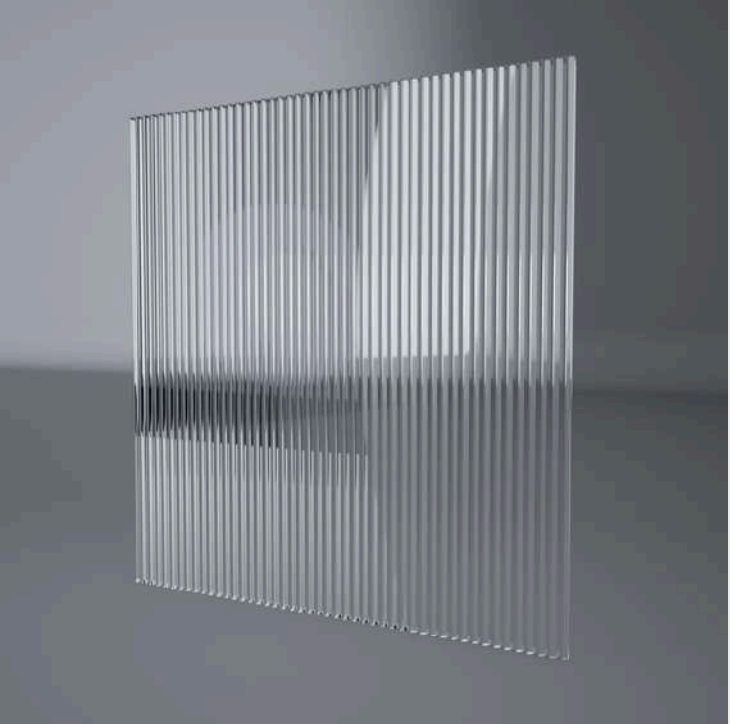

ANTISOL BRONZE

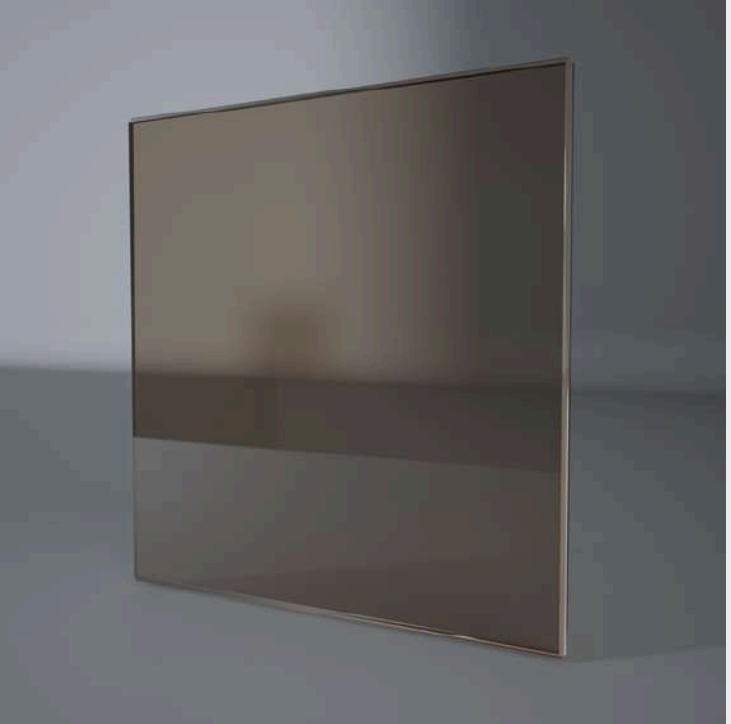

CATHEDRAL

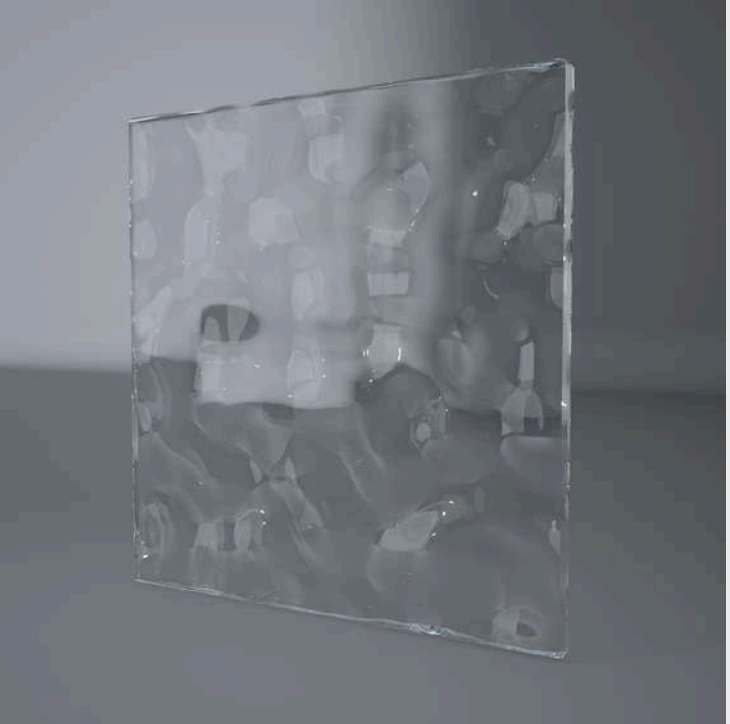

Loft Slim Glass

VISIOSUN

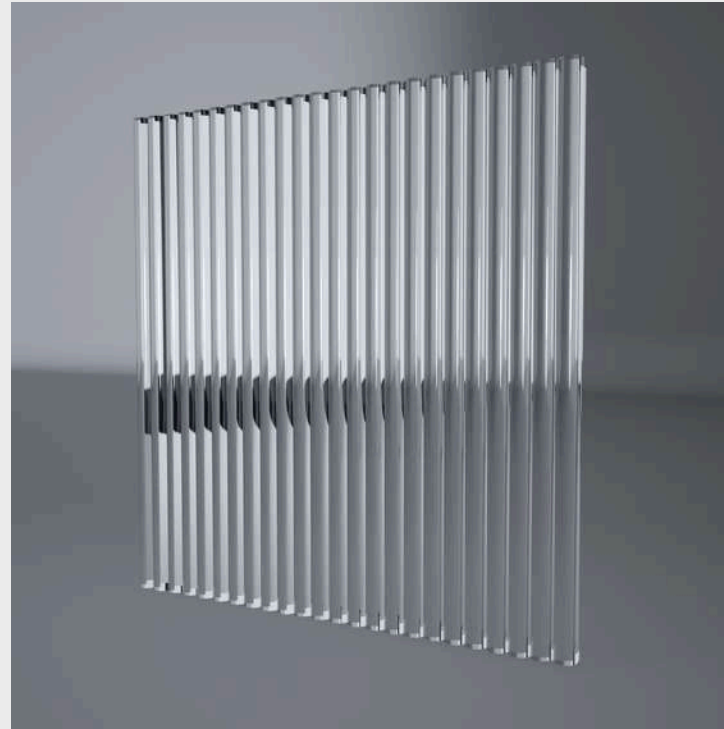

ANTISOL GRAPHITE

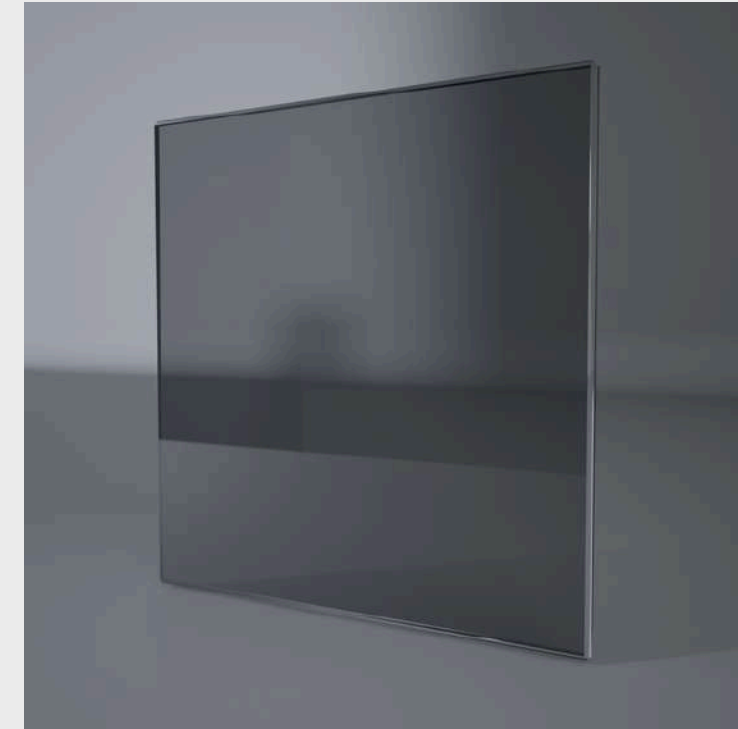

ANTISOL BRONZE

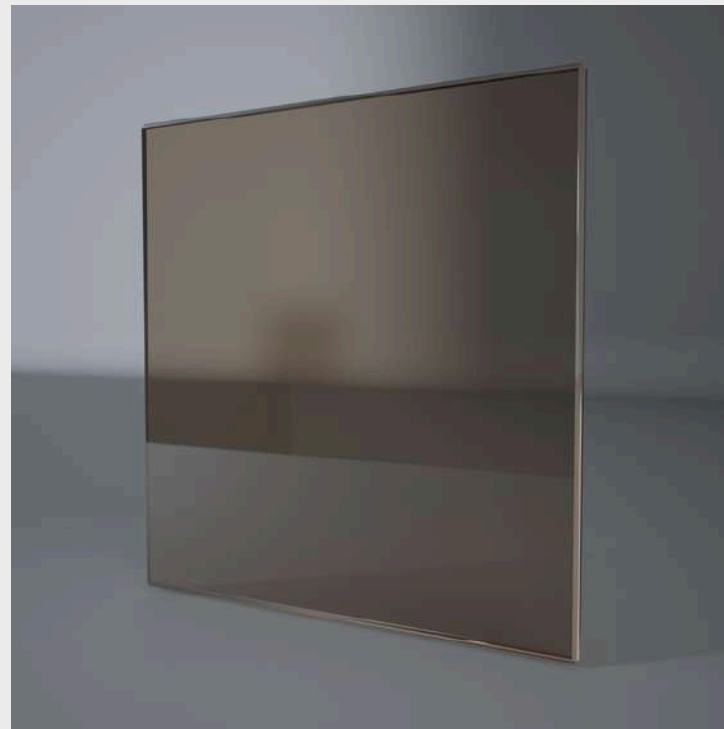

CATHEDRAL

